

# PENTAX<sup>®</sup>

OPERATING MANUAL

# MZ-S

QUARTZ  
DATE

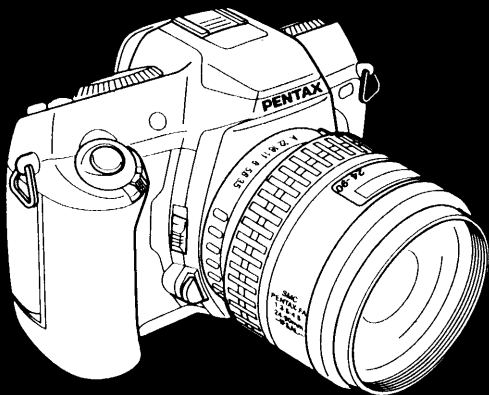

# WELCOME

Thank you very much for buying the Pentax MZ-S camera. Please read this manual before using the camera in order to get the most out of all the features and functions. Keep this manual safe, as it can be a valuable tool in helping you to understand all the camera's capabilities.

## Features

### The MZ-S has the following features:

- The heavy-duty body enhanced with the magnesium alloy.
- Six-focus-point SAFOX VII allows the six focus points in the viewfinder to auto focus even when the desired subject is not in the center; shooting with a fixed focusing point is also available.
- Shutter speed of maximum of 1/6000.
- Exposure data including shutter speed, aperture, etc. can be imprinted for each frame on a film.
- Slanted camera top facilitates visibility and controllability.

## FOR SAFE USE OF YOUR CAMERA

Although we have carefully designed this camera for safe operation, please be sure to follow precautions given on this page.



### WARNING

This mark indicates precautions that, if not followed, could result in serious injury to the operator.



### CAUTION

This mark indicates precautions that, if not followed, could result in minor or medium injury to the operator or damage to the equipment.



This mark indicates prohibited matters.



This mark indicates that caution should be taken.



### WARNING

- ⊘ The electronic circuits inside the camera contain high voltage working parts. Never attempt to disassemble the camera yourself.
- ⊘ Never touch internal parts of the camera if they become exposed from dropping the camera or for some other reason, as there is danger of an electric shock.
- ⊘ Wrapping the strap around your neck is dangerous. Make sure that small children do not get the strap caught around their neck.
- ⊘ Do not look directly at the sun through the camera, as viewing the sun for may damage your eyes, and/or parts of the camera (e.g: shutter blades, etc.)
- ⚠ Be sure to store batteries out of the reach of children. Seek medical assistance immediately if accidentally swallowed.



### CAUTION

- ⊘ Do not use the flash near anyone's eyes, as it may hurt them. Be particularly careful with the flash around infants.
- ⊘ Never try to disassemble, short or recharge the battery. Also, do not dispose of the battery in fire, as it may explode.
- ⚠ Remove the batteries from the camera immediately if they become hot or begin to smoke. Be careful not burn yourself during removal.

## PRECAUTIONS FOR YOUR CAMERA

Your Pentax camera is a high-precision mechanism. Handle it with great care.

### Precautions when taking pictures

- Do not use the camera where it may come in contact with rain, water, or any other liquid, because the camera is not weather, water, or liquid resistant. Should the camera get wet from rain, splashing water, or any other liquid wipe it off immediately with a dry soft cloth.
- Do not drop the camera or allow it to hit solid objects. If the camera suffers a shock or impact, take it to a Pentax service center for inspection.
- Be careful not to subject the camera to strong vibrations, shock or pressure. Use a cushion to protect the camera when carrying it in a motorcycle, car, boat, etc.
- Condensation on the interior or exterior of the camera may be extremely harmful to the camera mechanism as it may cause rust. Furthermore, if the camera is taken from warm temperature to a subfreezing one or vice versa, the formation of icelets may cause damage. In such a case, put the camera into a case or plastic bag so that any changes in temperature difference is minimized. Do not remove it from the bag until temperature has stabilized.
- Regular size color prints may cut off what appears on the extreme edges of the film frame. Compose your picture with a margin of safety at the edges.
- When a macro or telephoto lens is attached to the camera, the top part of the viewfinder may look dark due to the lens blocking the mirror. However, this does not affect the picture taken.

### Precautions for storage

- Avoid leaving the camera for extended periods in places where the humidity and temperature are very high, such as in a car.
- Do not store the camera in a closet with moth balls or in an area where chemicals are handled. Store it in a place with good dry air circulation to prevent the growth of fungus.

### Precautions for proper care

- Never touch the shutter curtain or mirror with your finger or any other object.
- Use a blower and lens brush to remove dust accumulated on the lens or viewfinder.
- Never use solvents such as paint thinner, alcohol or benzene to clean the camera.
- Electrical problems may often be caused by water, dirt or dust at points of electrical contact. Also check for battery leakage, traces of dirt or grease, or corrosion due to salinity or gas. If you cannot correct the problems, have your camera inspected at a Pentax service center. Repairs of this nature are not covered under the terms of the warranty and charges may be assessed.

### Other precautions

- The temperature range at which this camera functions properly is 50°C to -10°C (122°F to 14°F).
- A camera which has been submerged in water usually cannot be repaired. If such an accident should occur, it is advisable to contact a Pentax Service Center immediately.
- To maintain optimum performance, it is recommended that the camera be inspected every one or two years. If the camera has not been used for an extended period, or is being prepared for an important photographic session, it is recommended that you have the camera inspected or test shoot with it.
- Repairs deemed necessary due to usage of this product in an industrial or commercial application may not be covered under the terms of the Pentax warranty.
- The PENTAX warranty provides only for the repair of defects in materials or workmanship. Damage of any kind cannot be repaired at no charge under the terms of the warranty. If the difficulty is caused as a direct result of the product being used in conditions as outlined in the "Precautions for Your Camera" section or any other operation contrary to the instructions outlined in this manual, charges will be assessed and a repair quotation will be provided.

## PRECAUTIONS FOR BATTERY USAGE

- Use two 3V lithium batteries (CR-2 type).
- Misuse of the battery can cause hazards such as leakage, overheating, explosion, etc. The battery should be inserted with the "+" and "-" sides facing correctly.
- Battery performance may be temporarily hindered in low temperatures, but will recover in normal temperatures.
- Keep a spare battery on hand for replacement convenience when shooting outdoors or while traveling.
- If the built-in flash is used continuously, the battery may become warm, but it does not mean that the battery is faulty; it is one of the battery's characteristics.
- Replace the batteries at the same time. Do not mix battery brands, type or an old battery with a new one. It may cause explosion or overheating.

# CONTENTS

|   |           |
|---|-----------|
| FOR SAFE USE OF YOUR CAMERA .....                 | 1         |
| PRECAUTIONS FOR YOUR CAMERA .....                 | 2         |
| PRECAUTIONS FOR BATTERY USAGE .....               | 3         |
| NAMES OF WORKING PARTS .....                      | 8         |
| USING THIS OPERATING MANUAL .....                 | 10        |
| <b>SET UP .....</b>                               | <b>11</b> |
| <b>THINGS TO DO .....</b>                         | <b>11</b> |
| BEFORE TAKING PICTURES .....                      | 12        |
| STEP 1 Attaching the Strap .....                  | 12        |
| STEP 2 Loading the Batteries .....                | 13        |
| STEP 3 Attaching a Lens .....                     | 14        |
| STEP 4 Imprinting the date or time .....          | 16        |
| STEP 5 Adjusting the viewfinder's<br>dioptr ..... | 17        |
| STEP 6 Film loading .....                         | 18        |

## BASIC .....

### BASIC OPERATIONS .....

|  |    |
|--|----|
| QUICK AND EASY SHOOTING .....                  | 22 |
| POWER ON/OFF .....                             | 22 |
| QUICK AND EASY SHOOTING .....                  | 24 |
| TAKING A PICTURE .....                         | 27 |
| BUILT-IN FLASH-SMART FLASH .....               | 30 |
| USING THE BUILT-IN FLASH .....                 | 30 |
| SETTING THE RED-EYE REDUCTION MODE .....       | 33 |
| UNLOADING FILM .....                           | 34 |
| REWINDING THE FILM .....                       | 34 |
| SETTING THE FILM SPEED (ISO)<br>MANUALLY ..... | 36 |
| IMPRINTING EXPOSURE DATA .....                 | 37 |
| REPLACING THE BATTERIES .....                  | 40 |
| REPLACING THE CAMERA'S<br>BATTERIES .....      | 40 |
| REPLACING THE DATA BACK'S<br>BATTERY .....     | 42 |
| ADJUSTING THE DATA BACK .....                  | 44 |

## STEP UP

### ADVANCED OPERATIONS

|   |    |
|---|----|
| CAMERA OPERATIONS .....                   | 48 |
| CONSECUTIVE-FRAME DRIVE.....              | 48 |
| MULTIPLE EXPOSURES ON A SINGLE FRAME..... | 49 |
| SELF-TIMER MODE .....                     | 51 |
| AUTO BRACKETING .....                     | 53 |
| SETTING THE EXPOSURE MODE .....           | 56 |
| ABOUT THE HOLD SWITCH.....                | 57 |
| USING PROGRAMMED AE MODE.....             | 57 |
| USING SHUTTER-PRIORITY AE MODE .....      | 59 |
| USING APERTURE-PRIORITY<br>AE MODE.....   | 61 |
| USING METERED MANUAL MODE.....            | 62 |
| BULB EXPOSURES MODE.....                  | 64 |
| EXPOSURE COMPENSATION.....                | 65 |
| AE LOCK FUNCTION .....                    | 66 |
| SWITCHING THE METERING MODE .....         | 68 |
| USING MULTI(6)-SEGMENT METERING .....     | 68 |
| USING CENTER-WEIGHTED METERING.....       | 69 |
| USING SPOT METERING .....                 | 70 |
| ABOUT FOCUSING.....                       | 72 |
| USING AUTOFOCUS.....                      | 72 |
| FOCUSING MANUALLY.....                    | 76 |
| SELECTING THE FOCUS POINT .....           | 78 |
| USING FOCUS LOCK.....                     | 80 |

|                                    |    |
|------------------------------------|----|
| PREVIEWING THE DEPTH OF FIELD..... | 82 |
|------------------------------------|----|

### FLASH PHOTOGRAPHY

|  |     |
|--|-----|
| USING THE BUILT-IN FLASH .....                           | 84  |
| SETTING THE FLASH MODE .....                             | 84  |
| ADVANCED TECHNIQUES WITH THE BUILT-IN<br>FLASH.....      | 87  |
| USING EXTERNAL FLASH .....                               | 91  |
| FLASH FEATURES .....                                     | 91  |
| USING TTL AUTO FLASH .....                               | 92  |
| USING HIGH-SPEED SYNC WITH<br>THE AF360FGZ .....         | 93  |
| WIRELESS FLASH (AF360FGZ ONLY).....                      | 96  |
| USING BOTH THE BUILT-IN FLASH AND<br>EXTERNAL FLASH..... | 97  |
| USING CONTRAST-CONTROL-SYNC<br>FLASH MODE .....          | 99  |
| USING SLOW-SPEED SYNC .....                              | 101 |
| WHEN USING FLASH .....                                   | 103 |

### APPENDIX

|                                |     |
|--------------------------------|-----|
| PENTAX FUNCTIONS .....         | 106 |
| SETTING PENTAX FUNCTIONS.....  | 108 |
| SETTING A PENTAX FUNCTION..... | 110 |
| ACCESSORIES (OPTIONAL) .....   | 123 |
| TROUBLE SHOOTING .....         | 128 |
| SPECIFICATIONS TABLE .....     | 132 |
| WARRANTY POLICY .....          | 136 |

# NAMES OF WORKING PARTS

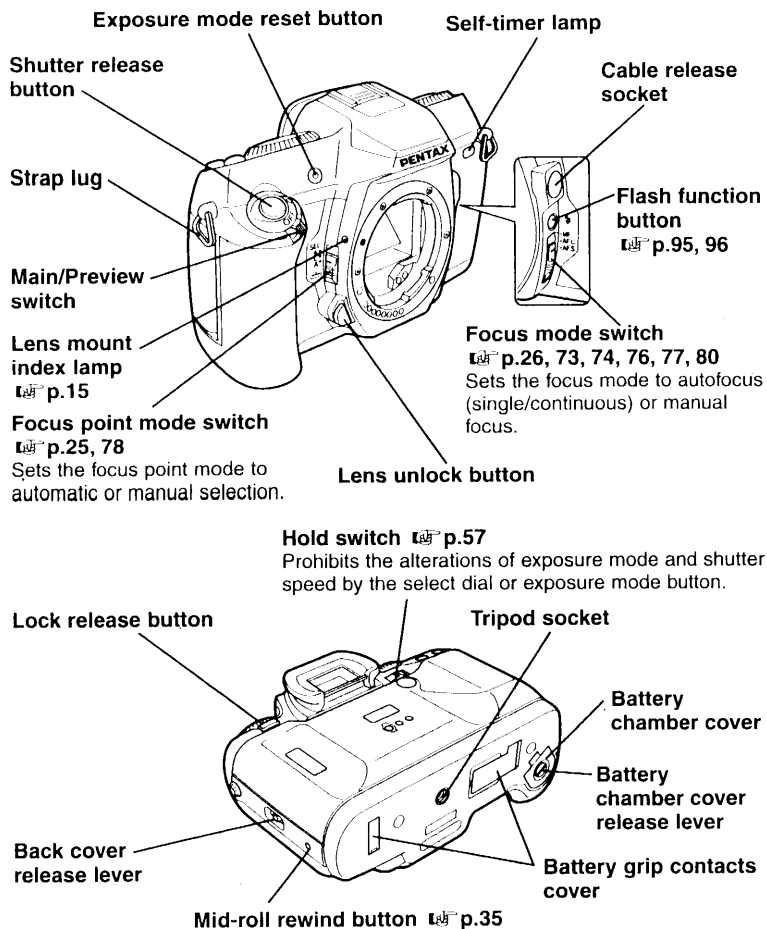

## Drive switch

Sets the drive mode to the single-frame (☞ p.24), consecutive-frame (☞ p.48), multi-exposure (☞ p.49), or self-timer mode (☞ p.51).

## LCD panel

Displays the current exposure mode, shutter speed, aperture, flash firing status, frame counter, and other information.

## Select dial

Sets various modes and settings.

## Hot shoe

For a Pentax-dedicated external flash unit.  
☞ p.92, 94, 98

## 2P sync terminal

## Exposure compensation dial

**Auto bracketing dial** ☞ p.53  
A set number of frames is taken consecutively automatically while the exposure is bracketed by  $\pm 1$  or  $\pm 1/2$  stop.

**Flash pop-up button** ☞ p.30,84  
Pops up the built-in flash to enable flash photography.

## Metering mode switch

☞ p.25, 66, 68, 69, 71  
Sets the metering mode to multi-segment, spot, or center-weighted metering.

## LCD illuminator button

☞ p.23  
Illuminates the LCD panel.

## AE lock button

☞ p.66  
Locks the current exposure setting for 20 sec.

## AF button

☞ p.26  
Activates autofocus.

## Diopter adjustment lever

☞ p.17

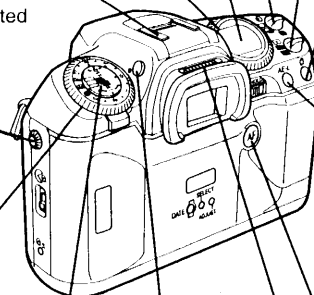

## USING THIS OPERATING MANUAL

This operating manual consists of the following sections.

### ◆ Things to Check

This section is before "Things to Do," and it explains cautions for using the camera and accessories, as well as the names of working parts.

### ◆ Things to Do

Explains the procedures to be followed before you use the camera for the first time.

It also explains how to load and rewind the film.

### ◆ Basic Operations

- Explains the easiest way to take pictures with the camera set to single-frame mode, programmed AE mode, multi-segment metering mode, automatic focus point selection, and AF mode.
- Using the Built-in Flash: Explains how to use the built-in flash.

### ◆ Advanced Operations

The camera's features are explained in detail.

- Picture-taking Techniques: Consecutive-frame mode, multi-exposure mode, self-timer mode, auto bracketing
- Setting the Exposure: Autoexposure modes (Programmed AE, Shutter-Priority AE, Aperture-Priority AE), metered manual exposure, bulb exposure, exposure compensation
- Setting the Metering Mode: Multi-segment metering, center-weighted metering, spot metering
- Focusing: Focus modes, focus point selection, manual focusing

### ◆ Flash Photography

- Tips: Tips on using flash in backlit conditions and at night, flash exposure settings, and effective flash range.
- Using a Pentax-Dedicated External Flash: Explains the operation for dedicated external flash units and high-speed sync and wireless mode features with the AF360FGZ.

# SET UP

## THINGS TO DO

|   |    |
|---|----|
| BEFORE TAKING PICTURES .....                    | 12 |
| Step 1 Attaching the Strap .....                | 12 |
| Step 2 Loading the Batteries .....              | 13 |
| Step 3 Attaching a Lens .....                   | 14 |
| Step 4 Imprinting the date or time .....        | 16 |
| Step 5 Adjusting the viewfinder's diopter ..... | 17 |
| Step 6 Film loading .....                       | 18 |

# BEFORE TAKING PICTURES

Things to do before using the camera for the first time.

## Step 1 Attaching the Strap

- 1 Pass the end of the strap through the strap lug from underneath, then pass the strap through the clasp from underneath.



The strap's clasp can be used to rewind the film in mid-roll or to alter the date or time. Position the clasp away from the camera body.

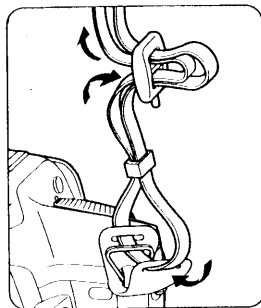

- 2 Follow the same procedure to attach the other end of the strap to the other strap lug.



### Using the strap pocket

The strap also has a pocket which can store the viewfinder cap, release socket cover, hot shoe cover or any other small accessory as illustrated.

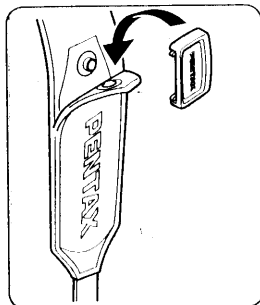

## Step 2 Loading the Batteries

- 1 As shown in the illustration, open the battery chamber cover by turning it with a coin.

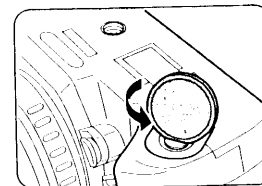

- 2 As shown in the illustration, load the two lithium CR2 batteries or equivalent into the chamber with the batteries' positive (+) contacts pointing down.

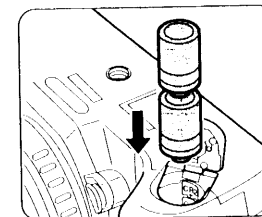

- 3 Push in the battery chamber cover firmly and use a coin to turn the cover clockwise to close.

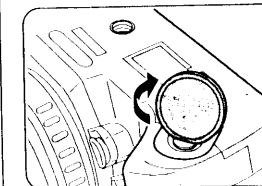

### About the Batteries

- Be sure to use two lithium CR2 batteries.
- If you want to use size-AA batteries, use the optional Battery Grip BG-10.
- When taking the camera to unfamiliar areas or when using in cold environments, take a spare set of batteries.
- See "Replacing the Batteries" to replace the batteries and read the cautions regarding the batteries. (p.41)



## Step 3 Attaching a Lens

### 1 Remove the body mount cap and rear lens cap.

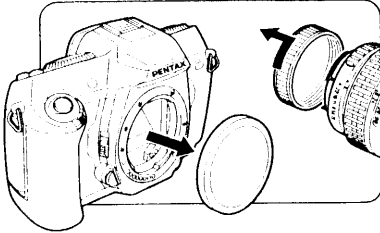

The body mount cap protects the inside of the camera from dust and scratches upon factory shipment. For long-term camera storage, the optional accessory "Body Mount Cap K" is also available.

### 2 Align the red dots on the lens and camera while attaching the lens to the camera, then turn the lens clockwise until it clicks in place.

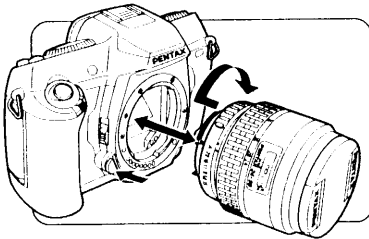

- After attaching the lens, try and turn the lens counterclockwise to make sure it is locked in place.

- When attaching the lens in the dark, turn on the camera's main switch and press the lens unlock button to turn on the lens mount index lamp on the camera.

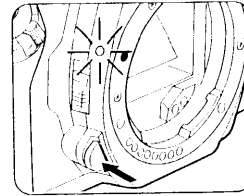

### 3 As shown in the illustration, remove the front lens cap.

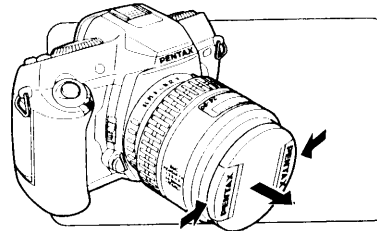

#### Handling the Lens

- To detach the lens, hold down the lens unlock button and turn the lens counterclockwise.

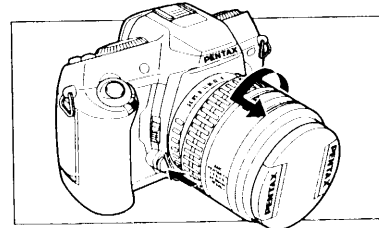

- We assume no responsibility nor liability for damages resulting from the use of lenses made by other manufacturers.
- Use a soft, dry cloth to keep the electrical contacts on the body mount and lens mount clean. Dirt or corrosion on the contacts can cause problems with the electrical system.

## Step 4 Imprinting the date or time

Imprint the date or time within the picture.

### 1 On the camera's back cover, press the DATE button to set the desired imprinting format.

Each time you press the DATE button, the display will change in the following sequence:

- The sample display below indicates May 1, 2001, 2:10 PM.  
YY indicates the year's last two digits, MM is the month, DD is the day, hh is the hour, and mm is the minute.

[YY MM DD] → [01 5 1]

[DD hh mm] → [ 1 14:10]

[-- -- --] → Blank

[MM DD YY] → [ 5 1 01]

[DD MM YY] → [ 1 5 01]



The date or time is imprinted on the lower right corner of the picture. If this part of the picture is light-colored (white, yellow, etc.), the imprinted date or time may be difficult to distinguish.

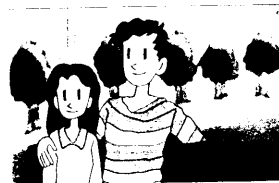
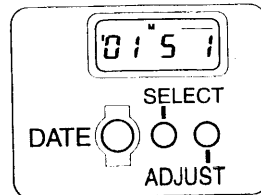

### NOTE

- To set the correct date and time, see "Setting the Date and Time" on page 44.
- If the imprinting looks too light or if the Data back's display looks light or shows nothing, replace the Data back's battery. (p.42)
- The date of the first frame will be imprinted in the multi-exposure mode.

## Step 5 Adjusting the viewfinder's diopter

Adjust the viewfinder's diopter to suit your eye's vision.

### 1 Look through the viewfinder and point the camera to a well-lit scene. Then move the diopter adjustment lever left or right until the autofocus frame in the finder looks sharp.

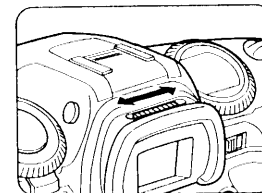

The diopter can be adjusted from -2.5 to +1.5m<sup>-1</sup> (per meter).

## Step 6 Film loading

### Automatic film speed setting

This camera is designed to use DX-coded films with ISO ratings from 25 to 5000.



We suggest that you first operate the camera with no film loaded to become familiar with its operations.



- When DX-coded film is used, the correct film speed is automatically set for the camera. If you use a non-DX coded film, you can set the film speed manually. ( 1.36 p.36)
- You cannot use an infra-red film. This camera uses infra-red rays to detect film transport so it may sensitize the film.

- 1 To open the back cover, slide the back cover release lever in the direction of the arrow.



### Remove the protective cover

- Before loading film for the first time after purchase, open the back cover and remove the protective card.
- Be careful not to touch the shutter curtains with the protective card.

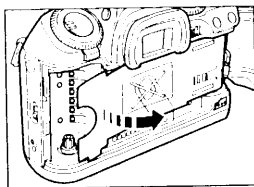

- Always load and unload film in the shade or by using your body to shade the camera.

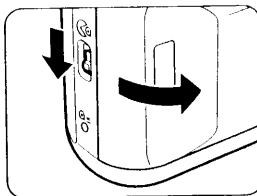

- 2 Place the film cartridge in the film chamber as shown in the illustration.

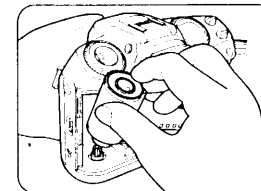

- 3 As shown in the illustration, pull the film leader out only far enough to reach the take-up spool.

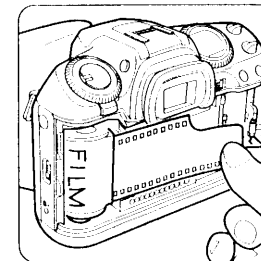

### ★Important★

The shutter curtains are fine-precision material. Do not touch them with your fingers or any other object while loading film.



- The DX information pins in the film chamber are used to read film speed. Keep them clean and free from scratches. To remove smudges, wipe them gently with a soft, dry cloth.
- If there is dirt on the film detector, film cannot be wound properly. Wipe them gently with a soft, dry cloth.

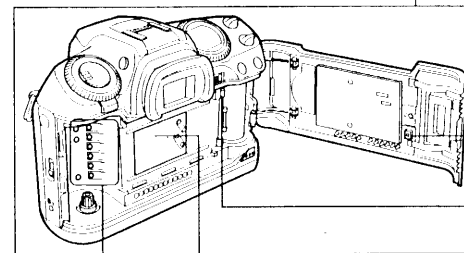

DX information pins    Shutter curtains

Imprint data emitter

Film detector

# BASIC OPERATIONS

- 4** Align the film leader with the film leader end mark and make sure that the film leader is positioned under the film retainer as shown in the illustration.



- If the end of the film leader is extremely bent, straighten it or cut off the bent portion.
- If you have pulled out too much film, push it back into the cartridge to reduce the slack.

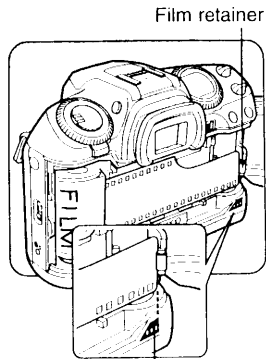

Film leader end mark

- 5** Close the back cover.

- 6** Turn the main switch to [ON].

The film will advance to frame 1 automatically, and the LCD panel will display the exposure counter and film status information.



**Incorrect film loading**

If the film is not loaded properly, the LCD panel will display **E**. Open the back cover and load the film again.

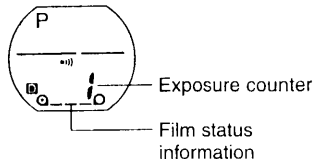
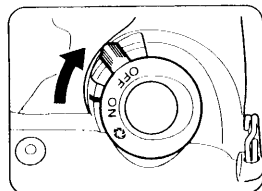
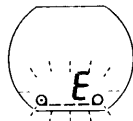

|   |    |
|---|----|
| QUICK AND EASY SHOOTING .....                 | 22 |
| POWER ON/OFF .....                            | 22 |
| QUICK AND EASY SHOOTING .....                 | 24 |
| TAKING A PICTURE .....                        | 27 |
| BUILT-IN FLASH-SMART FLASH .....              | 30 |
| USING THE BUILT-IN FLASH .....                | 30 |
| SETTING THE RED-EYE REDUCTION<br>MODE .....   | 33 |
| UNLOADING FILM .....                          | 34 |
| REWINDING THE FILM .....                      | 34 |
| SETTING THE FILM SPEED(ISO)<br>MANUALLY ..... | 36 |
| IMPRINTING EXPOSURE DATA .....                | 37 |
| REPLACING THE BATTERIES .....                 | 40 |
| REPLACING THE CAMERA'S<br>BATTERIES .....     | 40 |
| REPLACING THE DATA BACK'S<br>BATTERY .....    | 42 |
| ADJUSTING THE DATA BACK .....                 | 44 |

# QUICK AND EASY SHOOTING

## POWER ON/OFF

### 1 Turn on the camera.

① Turn the main switch to ON.

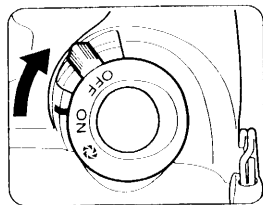

### 2 Turn off the camera.

① After you finish taking pictures, turn the main switch to OFF.



Be sure to turn the main switch to OFF to prevent accidental drain on the batteries.

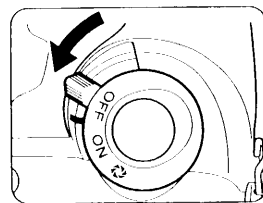

### Memo About the LCD Panel

The LCD panel displays the following indications:

- Exposure mode**  
The exposure mode is indicated. It can be set to P (Programmed AE), Tv (Shutter-Priority AE), Av (Aperture-Priority AE), or M (Metered Manual). ㉞ p.56
- Shutter speed/Aperture display**  
The shutter speed and aperture are indicated.
- Other indications**  
The ISO film speed, low battery warning, flash firing status, frame counter, and other information are displayed.

|                          |     |       |                                      |                         |
|--------------------------|-----|-------|--------------------------------------|-------------------------|
| <b>Exposure mode</b>     | P   | ..... | Programmed AE Mode                   | ㉞ p.24, 57              |
|                          | Tv  | ..... | Shutter-Priority AE Mode             | ㉞ p.59                  |
|                          | Av  | ..... | Aperture-Priority AE Mode            | ㉞ p.61                  |
|                          | M   | ..... | Metered Manual Mode                  | ㉞ p.62                  |
| <b>Flash indications</b> | ⊙   | ..... | Red-eye reduction flash indication   | ㉞ p.33, 85              |
|                          | A   | ..... | Automatic flash information          | ㉞ p.84                  |
|                          | ⚡   | ..... | Flash status information             | ㉞ p.30, 84              |
|                          | W   | ..... | Wireless flash mode                  | ㉞ p.86, 95              |
|                          | HS  | ..... | High-speed sync mode                 | ㉞ p.85, 93              |
| <b>Other indications</b> | ISO | ..... | Manual-set film speed                | ㉞ p.36                  |
|                          | PF  | ..... | Pentax function                      | ㉞ p.106                 |
|                          | ⋈   | ..... | Audible PCV signal                   | ㉞ p.52, 73, 74, 77, 110 |
|                          | ⚡   | ..... | Battery exhaustion warning           | ㉞ p.40                  |
|                          | D   | ..... | Imprinting exposure data information | ㉞ p.37                  |
|                          | ⊙   | ..... | Film status information              | ㉞ p.20,34               |

### NOTE

To see the LCD panel in the dark press the LCD illumination button. The panel will light up for about 10 seconds.

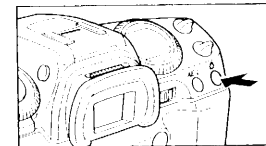

## QUICK AND EASY SHOOTING

For quick and easy shooting, set your camera for single-frame shooting, Programmed AE, multi-segment metering, automatic focus point mode, and autofocus.

### NOTE

To load the batteries and film or to attach the lens, see "Things to Do." (p.11)

## 1 Set the single-frame drive mode.

- 1 Set the main switch to [ON] position.
- 2 Set the drive switch to [□].  
One picture is taken each time the shutter release button is pressed.

### Memo

The drive mode can also be set to consecutive-frame mode (p.48), self-timer (p.51), or multiple-exposure mode (p.49).

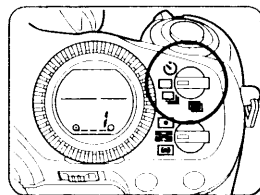

## 2 Set the Programmed AE Mode.

- 1 Turn the aperture ring to the [A] position while holding down the aperture-A lock button on the lens. [P] appears on the LCD panel to indicate that the Programmed AE Mode is set.

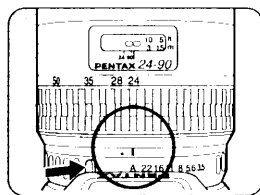
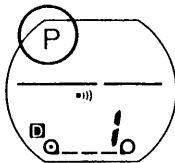

### Memo

When [P] is not displayed on the LCD panel, press the exposure mode reset button.

## 3 Set the multi(6)-segment metering mode.

- 1 Set the metering mode switch to [☉].

### Memo

### Multi-segment Metering

- When multi-segment metering is set, the scene's brightness is metered by six segments within the image area. So even in backlit conditions, the subject will not be underexposed because the other metering segments can detect the condition and the camera can compensate the exposure accordingly.
- The center-weighted metering and spot metering are also available. (p.69, 70)

## 4 Automatic selection of the Six Focus Points

- 1 Set the focus point mode switch to the down position at [A].

When the focus point mode is set to [A], the camera selects one of the six focus points to focus even when the subject is not at the center.

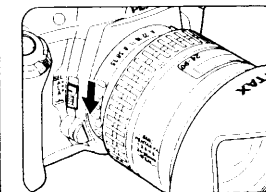
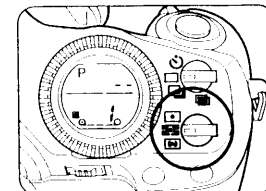
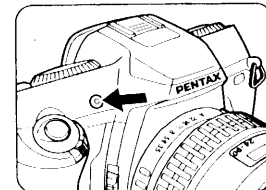



You can also manually select one of the six focus points to focus the subject.

☞ p.78

## 5 Set autofocus

- 1 Set the focus mode switch to the down position at [AF.S].

When the single AF mode [AF.S] has been set, press the shutter release button halfway down to focus. The picture cannot be taken unless focus is achieved. The focus will remain locked as long the shutter release button is held in the halfway down position.



### Other focusing methods

You can also focus in the following ways:

- MF...Focus manually. ☞ p.76
- AFC...Continuous focus. ☞ p.74
- AF button...This button works in the same way as shutter release button pressed halfway. Convenient especially in a situation where it's hard press the shutter release button halfway down.

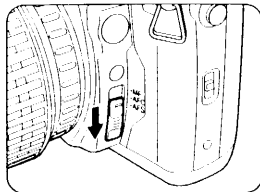
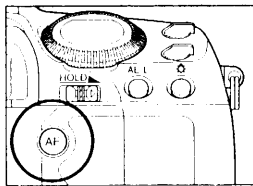

## TAKING A PICTURE



To load the film and batteries or to attach a lens, see "Things to Do." (☞ p.11).

### 1 Frame the subject

- 1 Look through the viewfinder and frame the subject.

Autofocus works with the six focus points in the viewfinder. Cover the subject with one of the focus points.

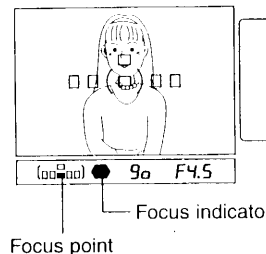

### Holding the camera

- Hold the camera firmly, with your left hand supporting the camera and lens as shown in the illustrations.

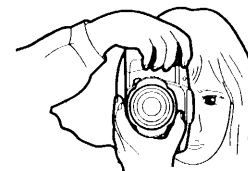
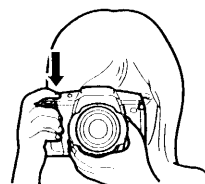

- To reduce camera shake, support your body or the camera on a solid object - a table, tree, or a wall for instance.
- Although there are individual differences among photographers, in general the shutter speed for a hand held camera is the inverse of the focal length. For example, 1/60 of second when focal length is 50mm, and 1/125 of second when it is 100mm. A tripod should be used for shutter speeds slower than this.
- When using a telephoto lens, a tripod that is heavier than the total weight of the camera and lens is recommended to avoid camera shake.

**Memo** Using a Zoom Lens

◆ Using the Manual Zoom Lens

To photograph a wider area, turn the zoom ring to the left. To magnify the subject, turn the zoom ring to the right.

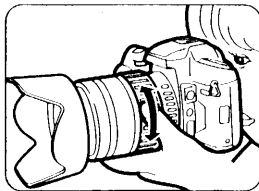

◆ Using the manual zoom function with a Power Zoom lens attached

Pull the power zoom ring toward the camera body until the words [POWER ZOOM] are hidden and turn the zoom ring to the right or left.

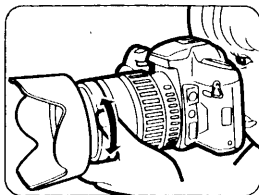

◆ Using the power zoom function with a power zoom lens attached

- ① Push the power zoom ring forward until the words [POWER ZOOM] appear beneath the power zoom ring.
- ② Turning the power zoom ring to the right brings the subject closer (telephoto) and turning it to the left makes the subject smaller (wide angle). To stop zooming, release the power zoom ring.

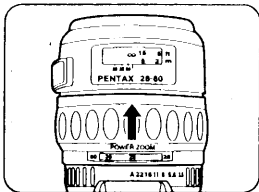

◆ Using the Power Zoom Function

- If a power zoom ring is attached, three zooming speeds are available. Turning the power zoom ring fully to the right or left, zooms the lens quickly.
- Turning it slightly gives you slow operation. At an intermediate position, the lens zooms at medium speed.

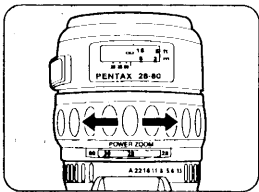

**2** Taking the picture

- ① Lightly press the shutter release button halfway down with your finger.

The exposure information (focus point, shutter speed, aperture, flash status) will be displayed in the viewfinder.

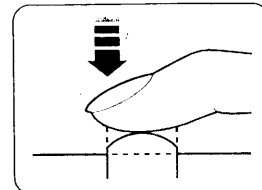

**Memo**

The viewfinder indication stays on for 10 seconds after the button is released from the halfway position.

**Memo**

Viewfinder Displays

Flash status indicator:  
Blinks when flash is required in indoor or low-light environments. Press the flash pop-up button to pop up the built-in flash. (p.30)  
On completion of recharging, the indicator remains lit.

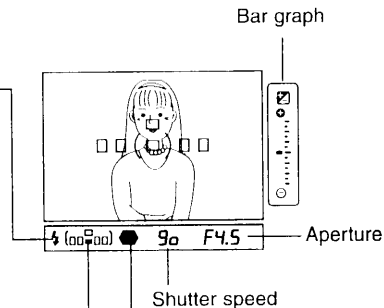

Focus point indicator:  
The focus point that achieves focus will light up. If the subject cannot be focused all points will light up.

Focus indicator:  
Lights when focus is achieved. If it blinks, it indicates that focus has not been achieved.

- ② Check the exposure information in the viewfinder and press the shutter release button completely.

BASIC OPERATIONS



# BUILT-IN FLASH - SMART FLASH

The basic procedure for using the built-in flash is explained below.



To set the built-in flash's flash mode or when using an external flash unit, refer to "Using external flash" on page 91.

## USING THE BUILT-IN FLASH

You can set the built-in flash to fire even when there is adequate existing light.



- When using the built-in flash, do not attach a hood to the lens. The hood will obstruct part of the flash.
- As a rule of thumb the distance for using the built-in flash (which varies with the lens used) is within about four meters (using ISO 400 film).

## 1 Enabling the built-in flash

- ① **Make sure the camera is on, then press the flash pop-up button.**

The built-in flash pops up and starts to recharge automatically.

When the built-in flash is charged and ready to fire, [⚡] is displayed on the LCD panel and in the viewfinder.

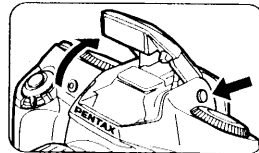
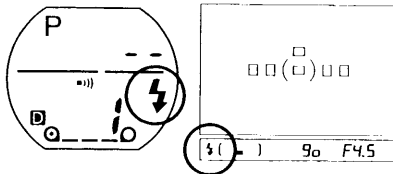

**What to do if an indication other than [⚡] is displayed**

Hold down the flash-function button and turn the select dial.

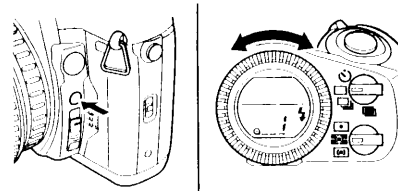

The flash mode is indicated on the LCD panel as shown below.

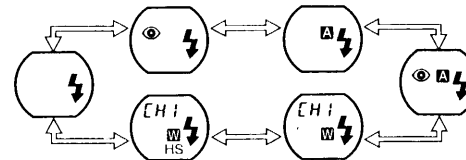

- The flash mode indications displayed on the LCD panel are explained in "Using Built-in Flash" on page 85.
- Auto flashing [Δ] can only be selected in the Programmed AE mode.



**Flash recommendation indicator**

When the shutter release button is pressed halfway down, if [⚡] blinks in the viewfinder and on the LCD panel, it is recommended that you use flash.

Also, if a telephoto lens is used and the subject is beyond the effective range of the built-in flash, use of a tripod is recommended to prevent camera shake.

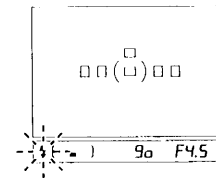

The [⚡] indicator may blink in the following modes:

- **Aperture-Priority AE Mode or Programmed AE Mode**  
The [⚡] indicator will blink if the subject is dark or backlit.
- **Shutter-Priority AE Mode or Metered Manual Mode**  
The indicator will blink if the subject is backlit. (It will not blink for a dark subject.)
- **Center-weighted metering or Spot metering**  
The indicator will blink only if the subject is dark. (It will not blink for a backlit subject.)

## 2 Firing the built-in flash

- 1 Check that [⚡] is displayed in the viewfinder or on the LCD panel, then press the shutter release button.

When the shutter release button is pressed all the way down the built-in flash will fire and then will start to recharge automatically.

When [⚡] is displayed again on the LCD panel or in the viewfinder, you can take another flash picture.



- The shutter cannot be released while the built-in flash is being recharged.
- If the built-in flash is used continuously, the batteries will get warm, but it does not mean that the batteries are faulty.



### When [⚡] blinks

When using an F or FA lens not suited for flash photography, [⚡] will blink in the viewfinder and on the LCD panel when the flash is ready and the shutter release button is pressed halfway down. Taking a picture while this warning is displayed may cause vignetting in the picture corners or semi-circular vignetting at the bottom of the picture.

See F and FA Lens Compatibility Table p.89

## 3 Retracting the built-in flash

- 1 After using the built-in flash, push down the flash head to lock it in the closed position.

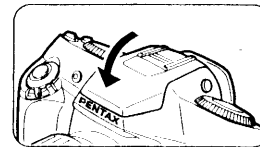

### AF illuminator

When the shutter release button is pressed halfway down where it is hard for autofocus to work, such as in a dark place, the built-in flash discharges continuously to provide illumination, making it easy for the autofocus to work. The effective range of AF illuminator is approx. 1m to 5m.

## SETTING THE RED-EYE REDUCTION MODE

**Red-eye reduction mode:** To make the eye's iris smaller, a low-output flash fires right before the picture is taken. This is to reduce the chances of red eye from occurring in the subject's eyes.

### 1 Setting the red-eye reduction mode

- 1 Turn the main switch to [ON]
- 2 While pressing the flash-function button, turn the select dial until [⊙] appears on the LCD panel.

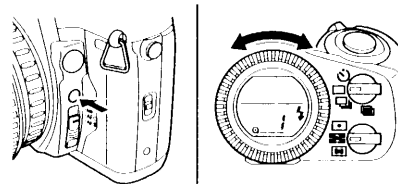

# UNLOADING FILM

Film rewind (auto/manual), setting the ISO for non-DX-coded film, and exposure data imprinting are covered here.

## REWINDING THE FILM



- Always unload film in the shade or by using your body to shade the camera.
- Never open the back cover until the whole film roll is completely rewind.
- When the film count reaches [30], an audible PCV signal beeps for about two seconds for film depletion warning with a blinking [Q] on the LCD panel.

### ◆ Automatic film rewinding



The shutter may be released a frame or more after the specified number of frames have been used as indicated on the film cartridge. However, those extra frames may be lost in processing. When you take important pictures, rewind the film when the film reaches the number of frames indicated on the film cartridge.

#### ① The film automatically rewinds at the end of the roll.

During rewinding, [ \_ \_ \_ \_ Q ] blinks on the LCD panel, indicating that the film is being rewind.

When the film is fully rewind, [ Q ] blinks and the exposure counter disappears from the LCD panel.

#### ② Before opening the back cover, check that [ Q ] is blinking.

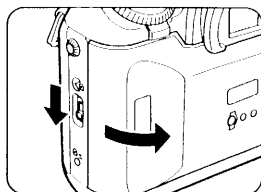
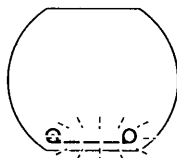

### ◆ Rewinding a film in mid-roll

If you wish to unload the film before exposing all the frames, use this function.



- If film that has been rewind in mid-roll is reloaded into the camera, picture-taking can start from the specified frame. ( 15 p.118)
- At the end of the film rewind, you can also leave the film leader outside the cartridge. ( 15 p.118)

#### ① Turn the main switch to ON.

#### ② Use the strap clasp's rod to press the mid-roll rewind button.



Avoid using anything other than the strap clasp's rod to press the mid-roll rewind button. If you have to use some other instrument such as a ballpoint pen, be sure to press the button gently without excessive force.

#### ③ Before opening the back cover, check that [ Q ] is blinking.

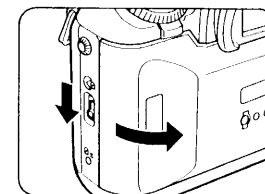
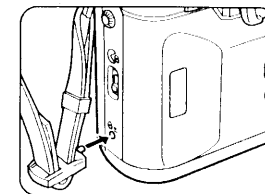

## SETTING THE FILM SPEED (ISO) MANUALLY

The camera automatically reads the film speed from the film's DX code. However, the film speed setting can be changed. If you use a non-DX coded film, set the film speed manually.

### 1 Load the film.

- 1 Load the non-DX-coded film.

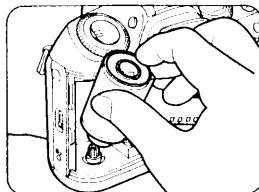

### 2 Setting the ISO speed

- 1 Hold down the lock release button and turn the exposure compensation dial to [ISO].

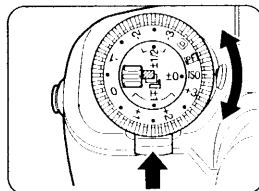

- 2 Turn the select dial to set the ISO speed.



- The ISO speed can be set from ISO 6 to 6400 in 1/3-EV increments.
- [ISO] is displayed when the film speed is set manually.

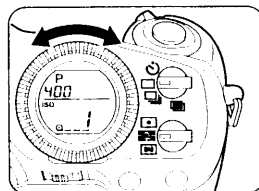

- 3 After setting the ISO speed, hold down the lock release button and turn the exposure compensation dial to [0].

#### Resetting the ISO speed

- If the exposure compensation dial is positioned at [ISO] with the non-DX-coded film loaded, pressing the exposure mode reset button sets the ISO speed to 100.
- If the exposure compensation dial is positioned at [ISO] with the DX-coded film loaded, pressing the exposure mode reset button cancels the manually-set ISO film speed.

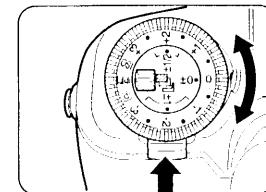

## IMPRINTING EXPOSURE DATA

The following exposure data can be imprinted on the negative: Exposure mode, shutter speed, aperture, exposure compensation value and auto bracketing. (Imprinting is enabled by default.)

### 1 Check the setting.

- 1 Turn the main switch to [ON].  
[D] displayed on the LCD panel indicates that exposure data imprinting is enabled.

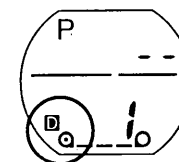

### 2 Enable or disable the data imprinting.

- 1 Hold down the lock release button and turn the exposure compensation dial to [D].

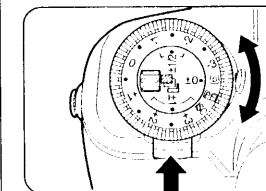

2 Turn the select dial to display [OFF] or [ON] on the LCD panel.



- If the exposure data imprinting is disabled with the exposure compensation dial set to other than **D**, the **D** indication disappears and the total number of film rolls is reset to [001].

3 Hold down the lock release button and turn the exposure compensation dial to [0].



**Imprinting exposure data**

- The exposure data will be imprinted on the negative as shown below. Before frame 1, the total number of film rolls, the ISO speed and imprint density will be imprinted.
- The exposure data imprint density varies with the films. You are recommended to make a test shooting. If the density is too low or too high, adjust it using the Pentax function No.15. (p.120)

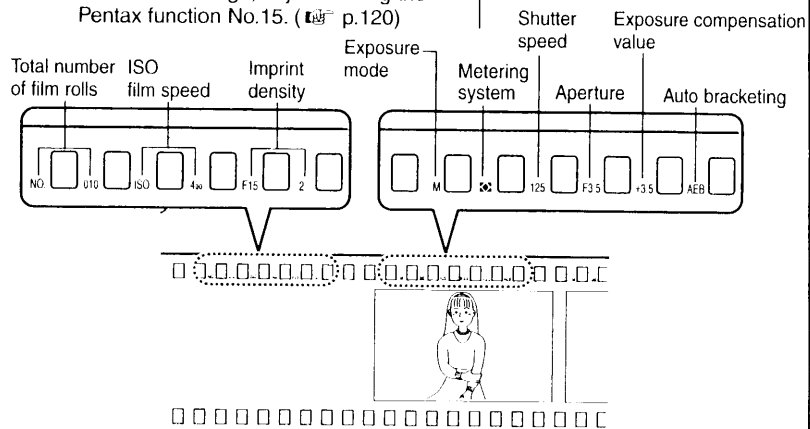
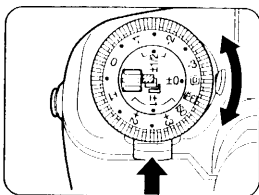
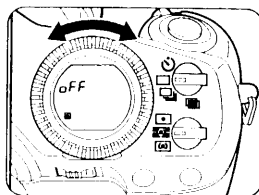

- In the multi-exposure mode, the first frame of data is imprinted.
- There are some cases where the imprint data is superimposed over the film perforations or text printed on film.

| Data type                   | Imprinted description  |
|-----------------------------|--|
| Total No. of film rolls     | Cumulative count of film rolls is imprinted. Counted up to 999 and recycled back to 001. The count is also reset to 001 if the exposure data imprinting is set to OFF.   |
| ISO speed                   | Loaded DX-coded film speed and manually set ISO speed is imprinted; ISO 6 to 6400 can be imprinted.  |
| Imprint density             | Selected item in the Pentax Function F15 is imprinted.   |
| Exposure mode               | Configured exposure mode is imprinted: M (Metered Manual Mode)/ Tv (Shutter-Priority AE Mode)/ Av (Aperture-Priority AE Mode)/ P (Programmed AE Mode).   |
| Metering system             | Defined metering system marking is imprinted: [  ] (Multi-segment)/ [  ] (Center-weighted)/ [  ] (Spot)  |
| Shutter speed               | The shutter speed displayed in the viewfinder is imprinted. For bulb exposure, [BU] is imprinted. For 1-second shutter speed, [1"] is imprinted.   |
| Aperture                    | Aperture displayed in the viewfinder is imprinted. When non-F/FA lenses or accessories having no information contacts as helicoid extension tube is used, [F-] is imprinted.   |
| Exposure compensation value | When the exposure compensation is not enabled, [ $\pm 0.0$ ] is imprinted. When either exposure compensation or auto bracketing alone is used, either compensation value is imprinted. If both auto bracketing and exposure compensation value are used, the sum is displayed. |
| Auto bracketing exposure    | [AEB] is displayed when the pictures are taken in auto bracketing mode.  |



Exposure data imprinting is powered by the camera body battery (CR-2) instead of the button cell for date and time imprinting.

# REPLACING THE BATTERIES

## REPLACING THE CAMERA'S BATTERIES

When the camera's lithium CR2 batteries are exhausted, replace with a new set.

### ◆ When the batteries are exhausted



When the batteries are exhausted, the LCD panel will display the low battery warning .

Keep a set of new lithium CR2 batteries handy. Even while the low battery warning is displayed, as long as the shutter works, a proper exposure will be obtained.

### ◆ When the batteries must be replaced

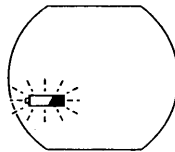
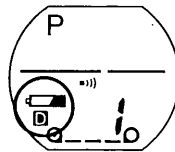
When the low battery warning  blinks, the information display in the viewfinder will be off and the shutter will not work. Replace the lithium CR2 batteries with new ones. (▶ p.13)



- When replacing the batteries, replace all of them at the same time. Do not use old and new batteries together. All the batteries should be of the same type and brand
- When the batteries are replaced, the following settings will take effect. All other settings will remain unchanged.
  - Red-eye reduction with built-in flash: .....Disabled
  - Automatic firing when built-in flash is popped up:.....Disabled
  - Wireless flash sync: .....Disabled
  - High-speed-flash sync:.....Disabled
  - Imprinting exposure data:.....Enabled
- If the camera has not been used for a long time, the LCD panel may still display the low battery warning  even with a new set of batteries. In this situation, turn on the camera and press the shutter release button halfway down. When the low battery warning  turns off, you can continue using the camera.



### Battery Life (using 24-exposure film rolls )

The number of 24-exposure film rolls that can be taken with a new set of batteries is indicated below.

|  | Number of film rolls<br>at 20°C/68°F | Number of film rolls<br>at -10°C/14°F |
|--|--------------------------------------|---------------------------------------|
| General existing light photography                   | about 50 rolls                       | about 30 rolls                        |
| Flash photography<br>(using flash 50% of the times)  | about 15 rolls                       | about 10 rolls                        |
| Flash photography<br>(using flash 100% of the times) | about 8 rolls                        | about 5 rolls                         |
| Bulb exposure time                                   | about 8 hours                        | about 2 hours                         |

- CR2 batteries were used under Pentax testing conditions. Actual battery life and performance may vary drastically depending on usage of autofocus, built-in flash and external conditions such as temperature and freshness of the battery.

## REPLACING THE DATA BACK'S BATTERY

If the date/time display or imprinting looks faint, replace the lithium CR2025 battery.

### Resetting the ISO speed

- Replace the battery when the data information on a picture or the LCD panel becomes weak or invisible. The battery will last for approximately 3 years. The data back uses one 3V lithium battery, type CR2025.
- After replacing the battery, set the correct date and time. (  p.44)

## 1 Remove the battery.

- ① Ensure that a film is not loaded, then open the back cover.

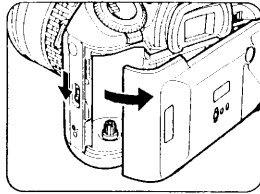

- ② Loosen the battery cover fixing screw (located near the upper left side of the pressure plate ) with a Phillips head screwdriver and then remove the battery chamber cover.

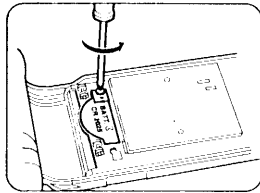

- ③ Remove the old battery.

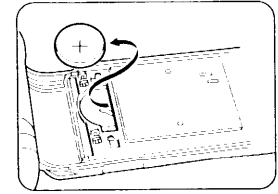

## 2 Install a new battery.

- ① Install a new battery with the + side facing up.

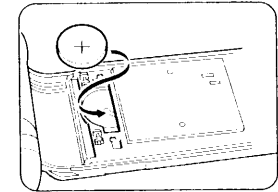

- ② Reinstall the battery chamber cover, and tighten the battery chamber fixing screw.

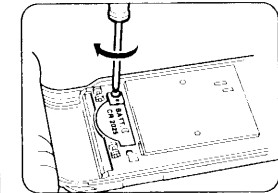

## ADJUSTING THE DATA BACK



Use the strap clasp's rod to press the buttons. Do not press the buttons with an object having a sharp tip.

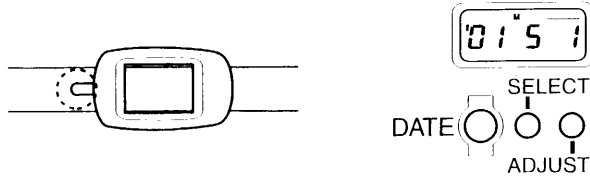

### 1 Adjusting the year/month/day.

- 1 Press the [SELECT] button to make the year, month or day you want to change blink. The digits blink in the following order.



The digits blink in the following order.  
Year - Month - Day - Year

- 2 Change the date with the [ADJUST] button.



The digit increases by one each time the [ADJUST] button is pressed. Holding the button for about 2 to 3 seconds will change the digits continuously.

- 3 Press the [SELECT] button to stop the digit from blinking, after you have changed the date. The adjusted date has been entered.

### 2 Adjusting the hour/minute.

- 1 Press the [SELECT] button to make the hour, minute or second (: ) you want to change blink.



The digits blink in the following order.  
Hour → Minute → : → Hour

- 2 Change the data ( hour or minute ) with the [ADJUST] button.



The digit increases by one each time the [ADJUST] button is depressed. Holding the button for about 2 to 3 seconds will change the digits continuously.

- 3 To change the second (: ), press the [SELECT] button until “ : ” will blink, and then press the [ADJUST] button in sync with a time signal to set the second to zero.
- 4 Press the [SELECT] button to stop the adjusted hour/minute from blinking.



#### Operational precautions

- To select or cancel the date imprinting or to select the format, see “Imprinting the Date and Time” on page 16.
- If the imprinting looks too light or if the Data back's display looks light or shows nothing, replace the Data back's battery. ( 10 p.42)
- The working temperature for data printing is 0°C - 50°C (32°F - 122°F).
- Imprinted data may appear too light under the low temperature.
- Use DX-coded films with ISO rating from 25 - 1600.
- If high-speed film with an ISO rating of 1000 or faster is used, the imprinted characters may blur.
- If film with ISO rating of 50 or slower is used, the printed characters may be dark or dim.
- If you release the shutter while the blinking data is being corrected, the data cannot be imprinted.



## ADVANCED OPERATIONS

|   |    |
|---|----|
| CAMERA OPERATION.....                     | 48 |
| CONSECUTIVE-FRAME DRIVE .....             | 48 |
| MULTIPLE EXPOSURES ON A SINGLE FRAME..... | 49 |
| SELF-TIMER MODE .....                     | 51 |
| AUTO BRACKETING .....                     | 53 |
| SETTING THE EXPOSURE MODE .....           | 56 |
| ABOUT THE HOLD SWITCH .....               | 57 |
| USING PROGRAMMED AE MODE.....             | 57 |
| USING SHUTTER-PRIORITY AE MODE.....       | 59 |
| USING APERTURE-PRIORITY AE MODE .....     | 61 |
| USING METERED MANUAL MODE .....           | 62 |
| BULB EXPOSURES MODE.....                  | 64 |
| EXPOSURE COMPENSATION .....               | 65 |
| AE LOCK FUNCTION .....                    | 66 |
| SWITCHING THE METERING MODE .....         | 68 |
| USING MULTI(6)-SEGMENT METERING.....      | 68 |
| USING CENTER-WEIGHTED METERING .....      | 69 |
| USING SPOT METERING .....                 | 70 |
| ABOUT FOCUSING.....                       | 72 |
| USING AUTOFOCUS.....                      | 72 |
| FOCUSING MANUALLY .....                   | 76 |
| SELECTING THE FOCUS POINT .....           | 78 |
| USING FOCUS LOCK .....                    | 80 |
| PREVIEWING THE DEPTH OF FIELD.....        | 82 |

## CAMERA OPERATION

Besides single-frame drive mode, the camera can be set as follows:

- **Consecutive-frame drive mode:** Pictures can be taken consecutively while holding down the shutter release button. p.48
- **Multi-exposure mode:** Expose the same frame multiple times. p.49
- **Self-timer mode:** A picture will be taken with a 12-second delay. Mirror lock-up can also be set to prevent camera shake. p.51
- **Auto bracketing:** Three pictures are taken consecutively as follows: Correctly exposed, underexposed, and overexposed. p.53

### CONSECUTIVE-FRAME DRIVE

Keep the shutter release button pressed to take pictures continuously.

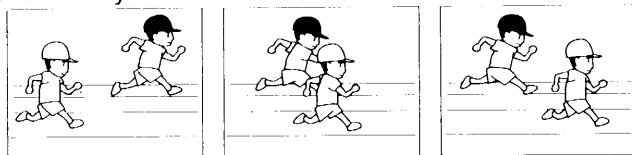

#### 1 Setting the consecutive-frame drive mode

- 1 Turn the main switch to [ON].
- 2 Turn the Drive switch to [ ].

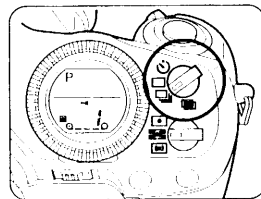

#### 2 Shooting consecutive frames

- 1 Press the shutter release button halfway down to focus the subject.
- 2 Press and hold down the shutter release button completely.
- 3 To stop taking consecutive pictures, take your finger off the shutter release button.



- When the focus mode switch is set to AFS (single), the focus is locked for the first frame and used for subsequent consecutive frames.
- When the focus mode switch is set to AFC (consecutive), the focus is set for each consecutive picture taken. The consecutive picture will be taken regardless of the focusing status.
- The shutter cannot be released while the built-in flash is being charged.

### MULTIPLE EXPOSURES ON A SINGLE FRAME

Picture can be exposed on the same frame multiple times until the multi-exposure mode is cancelled.

For example, you can first take a picture of a dark background, then use flash to photograph someone on the same frame.



## 1 Setting the multi-exposure mode

- 1 Turn the main switch to ON.
- 2 Turn the drive switch to [  ].

The frame counter will blink and show the same frame number until the multi-exposure mode is cancelled.

## 2 Using the multi-exposure mode

- 1 Take the first picture.
- 2 Take the second picture.



Subsequent pictures will be exposed on the same frame until the multi-exposure mode is cancelled.

## 3 Cancelling the multi-exposure mode

- 1 Turn the drive switch to any setting except [  ].

The multi-exposure mode is cancelled, and the film advances to the next frame.



The multi-exposure mode remains in effect even after the main switch is turned [OFF]. To cancel the multi-exposure mode, turn the drive switch to another setting.

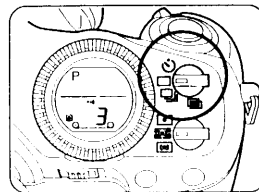
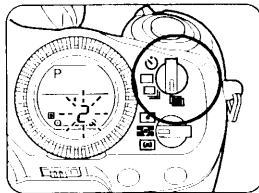

## SELF-TIMER MODE

After you pressing the shutter release button, the picture will be taken about 12 sec. later. Use the self-timer when you want to be in the picture or when you use mirror lock-up to prevent camera shake.

### 1 Setting the self-timer mode

- 1 Turn the main switch to ON.
- 2 Turn the drive switch to [  ].

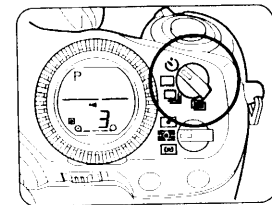

#### Preventing stray light from entering the eyepiece

Underexposure may occur if light enters the viewfinder during self-timer operation. If you intend to move away from the viewfinder, attach the supplied finder cap or use AE lock function (  p.66).

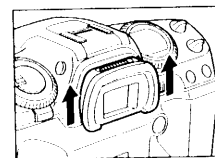

Detaching Eyecup FL

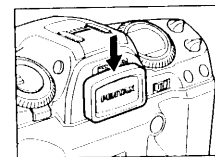

Attaching the finder cap

### 2 Using the self-timer mode

- 1 Press the shutter release button halfway down to focus the subject.

## 2 Press the shutter release button completely.

The shutter will be released about 12 seconds after the shutter release is pressed. The audible PCV signal is heard and the rate increases for the last two seconds.

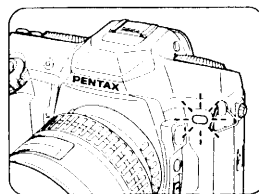

## 3 Cancelling the self-timer mode

### 1 Turn the drive switch to a setting except [ ].

The self-timer mode is cancelled.



The self-timer mode can be cancelled even during the self-timer is activated by placing the drive switch to other than the [ ] position.

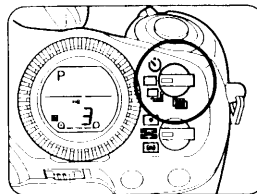

### Mirror lock-up

With mirror lock-up, you can prevent camera shake caused by the reflex mirror's movement. When the shutter release button is pressed, the reflex mirror stays up and the shutter is released about 2 seconds later.

To enable mirror lock-up, use Pentax Function No. 14 set to 2 (2-sec. mirror lock-up). ( p.119) Then use the self-timer mode.

## AUTO BRACKETING

When you press the shutter release button, three consecutive frames will be taken at different exposures. The first frame is exposed correctly. The second frame is underexposed, and the third frame is overexposed. The bracketing amount can be set to  $\pm 1/2$ EV or  $\pm 1$ EV.



Auto bracketing can also be used together with exposure compensation to bracket all the frames on the + or - side. ( p.65).



Correct exposure



-1EV underexposure

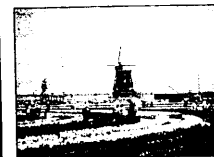

+1EV overexposure



- If the exposure compensation amount is small, the effect will not be so noticeable with print film.
- The number of auto bracketed frames and the bracketing sequence can be altered with a Pentax Function. ( p.113,114)

## 1 Setting the auto bracketing mode

- 1 Turn the main switch to [ON].
- 2 Set the auto bracketing dial to  $\pm 1/2$  or  $\pm 1$  EV.

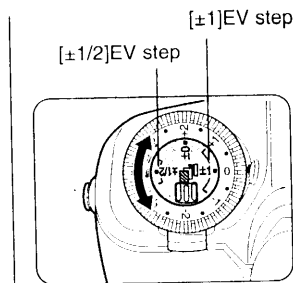

## 2 Using the auto bracketing mode

- 1 **Press the shutter release button halfway down to focus the subject.**

The bar graph is displayed in the viewfinder and the current exposure compensation amount blinks.



- When the focus mode switch is set to AF.S (single), the focus is locked for the first frame and used for subsequent consecutive frames.
  - When the focus mode switch is set to AF.C (continuous), the focus is set for each consecutive picture taken. The consecutive picture will be taken regardless of the focusing status.
- 2 **Hold down the shutter release button.**

In the viewfinder, the bar graph indicates the correct exposure for the first frame. For the second frame, it indicates the minus side for underexposure. For the third frame, it indicates the plus side for overexposure.



If you let go of the shutter release button during auto bracketing, the auto bracketing exposure setting will remain effective for about 20 sec. After that, the auto bracketing exposure for the first bracketed frame will take effect.

## 3 Cancelling auto bracketing

- 1 **Set the auto bracketing dial to  $[\pm 0]$ .**
- The auto bracketing mode is cancelled.

No exposure compensation

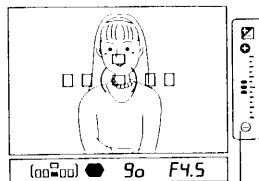

Exposure bar graph

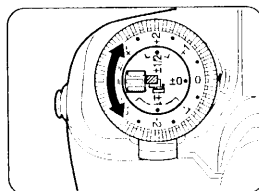

### Auto bracketing in combination with the drive modes

You can combine consecutive-frame drive mode, self-timer mode and multi-exposure mode in addition to a single-frame shooting for auto bracketing.



### Taking pictures underexposed or overexposed only

You can use the auto bracketing mode for only underexposure or overexposure shots by combining the operation with exposure compensation. (Refer p.65)

#### ● Taking pictures of overexposure only

$[\pm 1/2]$  step (EV) ..... Turn the exposure compensation dial to  $[+1/2]$ .

1st frame= $+1/2$ EV, 2nd frame= $\pm 0$ EV, 3rd frame= $+1$ EV

$[\pm 1]$  step (EV) ..... Turn the exposure compensation dial to  $[+1]$ .

1st frame= $+1$ EV, 2nd frame= $\pm 0$ EV, 3rd frame= $+2$ EV

#### ● Taking pictures of underexposure only

$[\pm 1/2]$  step (EV) ..... Turn the exposure compensation dial to  $[-1/2]$ .

1st frame= $-1/2$ EV, 2nd frame= $-1$ EV, 3rd frame= $\pm 0$ EV

$[\pm 1]$  step (EV) ..... Turn the exposure compensation dial to  $[-1]$ .

1st frame= $-1$ EV, 2nd frame= $-2$ EV, 3rd frame= $\pm 0$ EV

## SETTING THE EXPOSURE MODE

The following exposure modes are provided.

- **Programmed AE Mode:** The camera automatically selects the best combination of aperture and shutter speed settings. p.57
- **Shutter-Priority AE Mode:** You set the shutter speed and the camera sets the aperture automatically. p.59
- **Aperture-Priority AE Mode:** You set the aperture and the camera sets the shutter speed automatically. p.61
- **Metered Manual:** You set both the shutter speed and aperture while the camera indicates the proper exposure. p.62
- **Bulb exposure:** The shutter remains open as long as the shutter release button is held down. p.64



### Switching the exposure mode

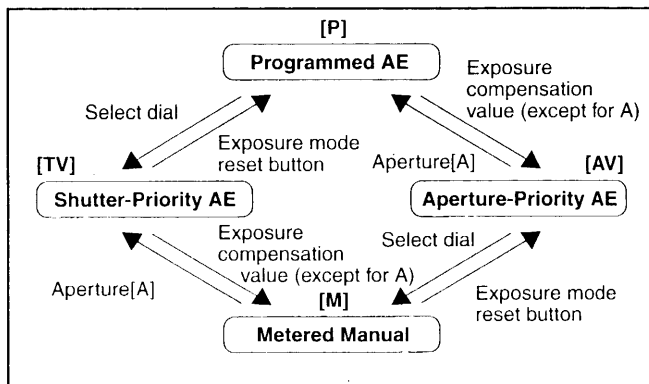

- **Exposure compensation:** It allows you to deliberately overexposure or underexposure a subject. p.65
- **AE lock:** You can lock the exposure setting before you take the picture. p.66

## ABOUT THE HOLD SWITCH

You can keep the exposure mode or shutter speed from being changed if the select dial is inadvertently rotated or exposure mode button is pressed.

- 1 **Slide the [HOLD] switch to the right.**  
Operation of the select dial or exposure mode button is disabled. Rotating the select dial or pressing the exposure mode button would cause the [HOLD] characters to blink in the LCD panel.
- 2 **To turn off the hold mode, slide the [HOLD] switch back to the left position.**

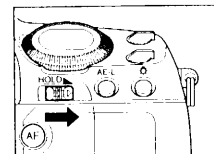

Features other than the exposure mode and shutter speed remain enabled even while the [HOLD] switch is in the right position. For example, rotating the select dial or pressing the exposure mode button is effective for setting the film speed or the Pentax functions' even in the [HOLD] mode.

## USING PROGRAMMED AE MODE

For easy picture taking, use this mode. In the Programmed AE Mode, the camera automatically selects the best combination of aperture and shutter speed setting allowing you to take pictures by simply pressing the shutter release button.

### 1 Setting Programmed AE Mode

- 1 **Turn the main switch to [ON].**
- 2 **Set the lens aperture ring to [A] position while holding down the aperture-A lock button on the lens.** [P] appears on the LCD panel to indicate that the Programmed AE Mode is set.

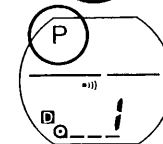
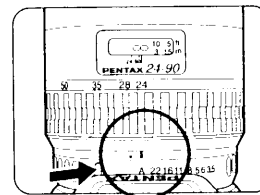



If [P] is not displayed on the LCD panel, press the exposure mode reset button.

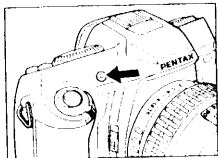

## 2 Using Programmed AE Mode

① Look through the viewfinder and frame the subject.

② Press the shutter release button halfway down.

The picture-taking information (focus point area, shutter speed, aperture value, flash status) is displayed on the LCD panel and in the viewfinder.

③ Check the viewfinder information and press the shutter release button completely.



### What to do if the shutter speed and aperture setting blink

If the subject is too bright or too dark, the selected shutter speed and aperture setting display in the viewfinder will blink. When the subject is too bright, select a darker subject. Use a flash if the subject is too dark.

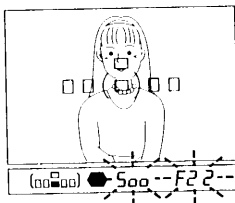
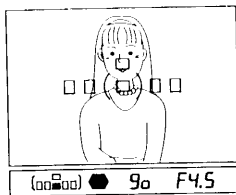

## 1 USING SHUTTER-PRIORITY AE MODE

Allows the user to directly control the shutter speed. This mode is suitable for freezing the action with a fast shutter speed or capturing a flowing dynamic image with a slow shutter speed. When the desired shutter speed is selected, the appropriate aperture is automatically set by the camera for a proper exposure according to the brightness of the subject.

### 1 Setting Shutter-Priority AE Mode

① Turn the main switch to [ON].

② Set the lens aperture ring to [A] position while holding down the aperture-A lock button on the lens.

③ Turn the select dial to set the desired shutter speed.

The shutter speed and aperture value will be displayed on the LCD panel.



- With the HOLD switch set to the right position [On] the shutter speed cannot be changed.

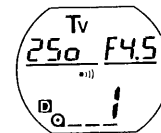
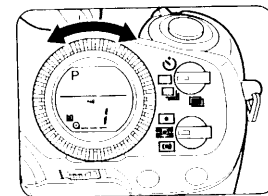
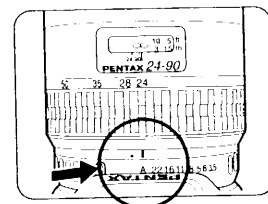

## 2 Using Shutter-Priority AE Mode

- 1 Look through the viewfinder and frame the subject.
- 2 Press the shutter release button halfway down.  
The picture-taking information (focus point area, shutter speed, aperture value, flash status) is displayed on the LCD panel and in the viewfinder.
- 3 Check the viewfinder information and press the shutter release button completely.

**Memo** What to do if the shutter speed or aperture value blinks

If the subject is too bright or too dark, the aperture setting display in the viewfinder blink. When the subject is too bright, choose a faster shutter speed. If the subject is too dark, choose a slower shutter speed.

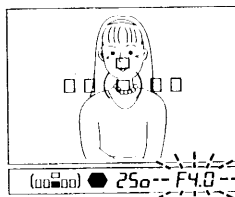

**Memo**

If both the shutter speed and aperture value displays blink, it means that the camera cannot expose the picture correctly even if the shutter speed is adjusted. Select a darker subject if it is too bright, or use a flash if it is too dark.

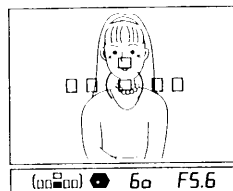

## 1 USING APERTURE-PRIORITY AE MODE

Allows the user to directly control the lens aperture. This mode is ideal for shooting landscapes with increased depth of field, or a portrait against a blurred background. When the desired aperture is selected, an appropriate shutter speed is automatically set by the camera for a proper exposure. When a smaller aperture (larger f/number) is set, the depth of field will be increased. When a large aperture (small f/number) is set, the depth of field will be decreased.

### 1 Setting the Aperture-Priority AE Mode

- 1 Turn the main switch to ON.
- 2 Set the lens aperture ring to any position other than [A] while holding down the aperture-A lock button on the lens.

**Memo**

[Av] will be displayed on the LCD panel. If it is not displayed, press the exposure mode reset button.

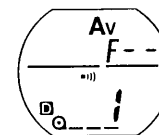
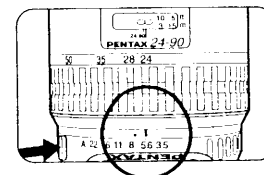

### 2 Using Aperture-Priority AE Mode

- 1 Look through the viewfinder and frame the subject.
- 2 Press the shutter release button halfway down.  
The picture-taking information (focus point area, shutter speed, aperture value, flash status) is displayed on the LCD panel and in the viewfinder.
- 3 Check the viewfinder information and press the shutter release button completely.

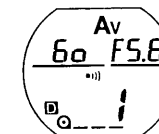
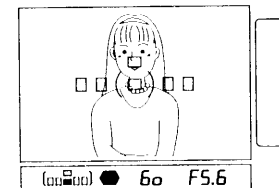

UP  
ADVANCED OPERATIONS



**Memo** What to do if the shutter speed and aperture value blink

If the subject is too bright or too dark, the shutter speed display in the viewfinder will blink. When the subject is too bright, choose a smaller aperture (larger f/number), if available; when it is too dark, choose a larger aperture (smaller f/number), if available.

**Memo**

If the shutter speed or aperture display blinks, it means that the camera cannot expose the picture correctly even if the aperture is adjusted.  
If the subject is too bright, select a darker subject. Use a flash, if it is too dark.

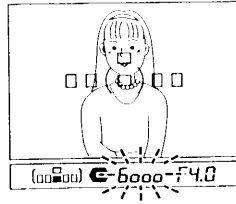
**USING METERED MANUAL MODE**

Allows the user direct control over all exposure settings. The Metered Manual Mode is a convenient exposure mode for taking pictures using the same shutter speed and aperture setting combination, or taking creatively under or over exposed photographs.

**1** Setting the Metered Manual Mode

- 1 Turn the main switch to ON.
- 2 If the lens aperture ring has been set to A, turn the lens aperture ring to the desired aperture setting while holding down the aperture-A lock button.

- 3 Turn the select dial to set the desired shutter speed.

The manually-set shutter speed is displayed on the LCD panel.

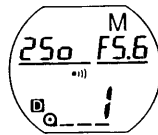
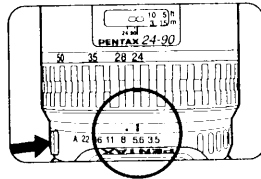
**2** Using Metered Manual Mode

- 1 Look through the viewfinder and frame the subject.
- 2 Press the shutter release button halfway down.

The picture-taking information (shutter speed, aperture value, flash status) is displayed on the LCD panel.

If multiple [●] dots are displayed on the bar graph, it indicates that a correct exposure has not been set. Adjust either the aperture or shutter speed until a dot is displayed in the center of the bar graph.

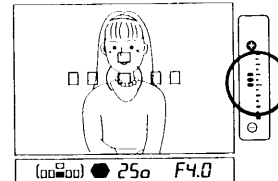
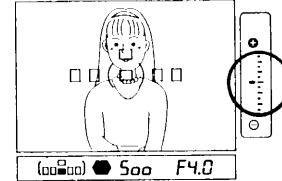
**Incorrect exposure setting****Correct exposure setting****Memo** About the viewfinder bar graph

If the [●] dots are on the minus side of the bar graph, it indicates underexposure. If they are in the plus side, it indicates overexposure. If the exposure setting exceeds  $\pm 3\text{EV}$ , [⊖] or [⊕] blinks.

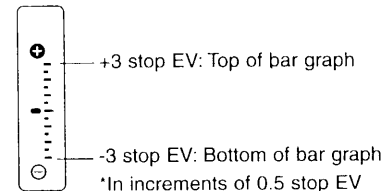

- ③ Check the viewfinder information and press the shutter release button completely.

**Memo** What to do if the shutter speed and aperture value blink

If both the shutter speed and aperture displays blink, it means that the camera cannot expose the picture correctly. If the subject is too bright, select a darker subject. Use a flash, if it is too dark.

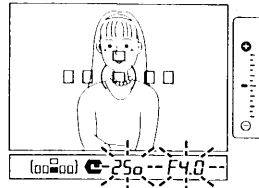

## BULB EXPOSURES MODE

This mode is useful for the long exposures required for shooting night scenes and fireworks. The shutter remains open as long as the shutter release button is held down.

### 1 Setting bulb

- ① Turn the main switch to [ON].
- ② If the lens aperture ring has been set to [A], turn the lens aperture ring to the desired aperture while holding down the aperture-A lock button.

**Memo**

If the lens aperture ring has been set to [A], the maximum aperture will be used.

- ③ Turn the select dial toward the right until [bu] is displayed on the LCD panel.

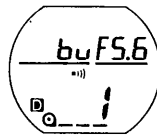
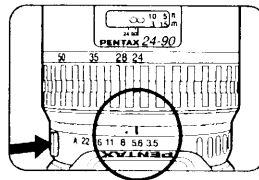

### 2 Using the Bulb Mode

- ① Look through the viewfinder and frame the subject.
- ② Press the shutter release button halfway down. "bu" and the aperture value (only a guideline; displayed on F and FA lenses) is displayed in the LCD panel and the shooting information (focusing point, bu, aperture) is displayed in the viewfinder.
- ③ Keep pressing the shutter release button, and let go when the desired exposure time elapses. The shutter remains open for as long as the shutter release button is held down.

**Memo** About bulb exposures

- To prevent camera shake during bulb exposures, use a sturdy tripod and the optional "Cable Switch CS-105, CS-130 or Release Timer Switch TS-110".
- Up to approx. 8 hours of time exposure are possible with new batteries at room temperature.

## EXPOSURE COMPENSATION

The exposure compensation allows you to deliberately overexposure (brighten) or underexposure (darken) a subject, or compensate for difficult lighting conditions which may fool the camera's built-in exposure meter. The exposure compensation range is -3EV to +3EV in 0.5EV steps.

**Memo**

Exposure compensation does not work in the Bulb Exposure Mode.

### 1 Setting the exposure compensation

- ① Turn the exposure compensation dial while holding down the lock release button. Turn the dial to the [+] side to obtain overexposure. Turn the dial to the [-] side to obtain underexposure.

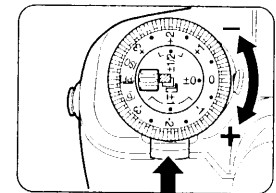

**Bar graph in the viewfinder**

When using exposure compensation a bar graph is displayed in the viewfinder.

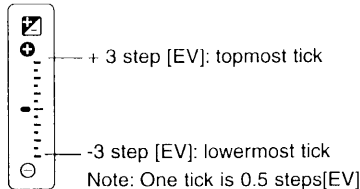

With the exposure compensation of the metered manual exposure, adjust the aperture value or shutter speed so that multiple dots in the viewfinder are made into one.

**AE LOCK FUNCTION**

You can lock the exposure setting before you take the picture. If the subject is too small for a proper exposure setting to be obtained, you can zoom in on the subject to obtain a proper exposure setting. Then you can lock the exposure setting and recompose the shot before taking the picture.

**1****Determining the exposure and metering modes.**

- 1 Select the exposure mode from the Programmed AE (p.57), Shutter-Priority AE (p.59) or Aperture-Priority AE (p.61)



AE lock cannot be used with metered manual and bulb exposures.

- 2 Setting spot metering (p.70).



If the subject is too small to be correctly metered for exposure or if a small element of the scene requires more precise metering, you can use the spot metering to narrow down the measuring area for exposure.

**2****Lock the exposure setting**

- 1 Look through the viewfinder and position the area to be measured with the spot metering frame.
- 2 Press the shutter release button halfway down.
- 3 Check the picture-taking information in the viewfinder and press the AE lock button [AE-L].
  - In the viewfinder, [ \* ] will be displayed. The current exposure setting will be locked for about 20 sec.
  - While [ \* ] is displayed, the picture can be taken with the locked exposure setting.
  - To cancel AE lock, press the AE lock button again.

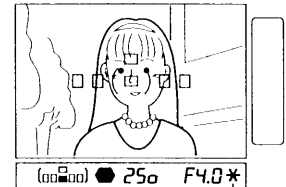
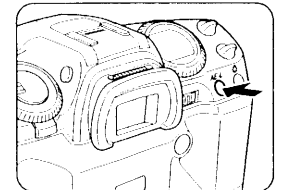
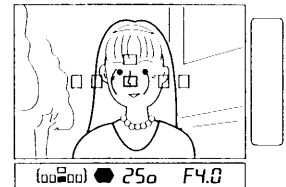

AE lock indicator

- 4 Recompose the picture and press the shutter release button completely.



Depending on the reflectivity of the subject to be metered a certain amount of exposure compensation may be required.

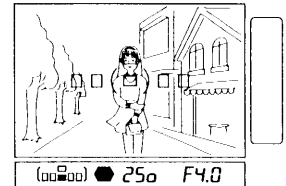

## SWITCHING THE METERING MODE

Multi (6)-segment metering, center-weighted metering, or spot metering mode can be selected in this camera. Select the desired metering mode with the metering mode switch.

### USING MULTI(6)-SEGMENT METERING

This mode automatically measures light in six different zones, enabling proper exposure value in a wide variety of normal and adverse lighting conditions.



When a lens other than an A, F or FA lens is attached, the center-weighted metering mode is automatically set even if you select the multi-segment metering mode.

#### 1 Setting the multi-segment metering mode

- 1 Set the metering mode switch to [  ].

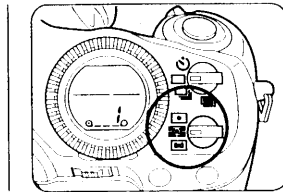

#### 2 Using multi-segment metering

- 1 Frame the subject, then press the shutter release button halfway down.



With multi-segment metering, the scene in the viewfinder is metered by six different zones as shown in the illustration.

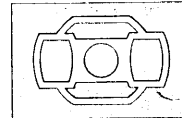

- 2 Check the viewfinder information, then press the shutter release button completely.

### USING CENTER-WEIGHTED METERING

This mode does not automatically compensate for back lighted or spotlighted scenes like the Multi(6)-Segment Metering Mode. Creative exposure control is decided by the user.



Multi-segment metering is recommended for most subjects. Set the metering mode switch to [  ].

#### 1 Setting center-weighted metering

- 1 Set the metering mode switch to [  ].

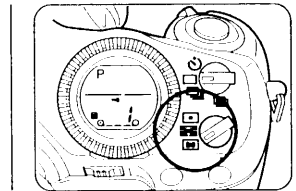

## 2 Using center-weighted metering

- 1 Frame the subject, then press the shutter release button halfway down.



The metering pattern in the illustration shows that the upper part of the pattern (in the center of the viewfinder) has more sensitivity to light than the lowest part. This metering mode may not be able to compensate for backlit subjects.

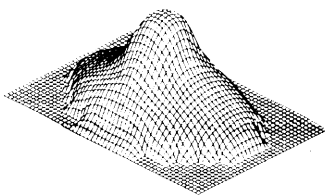

- 2 Check the viewfinder information, then press the shutter release button completely.

## USING SPOT METERING

This mode measures light only in the small area in the center of the viewfinder. You can use AE lock ( p.66) to lock the spot metering exposure and recompose to take the picture.



Multi-segment metering is recommended for most subjects. Set the metering mode switch to [  ].

## 1 Setting the spot metering mode

- 1 Set the metering mode switch to [  ].

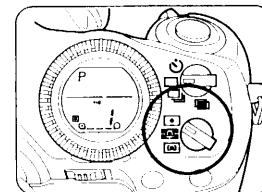

## 2 Using spot metering

- 1 Frame the subject, then press the shutter release button halfway down.



- With spot metering, the exposure is weighted on the small area at the center, as shown in the illustration.

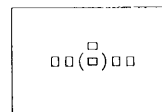

- With spot metering, the exposure setting cannot be locked by pressing the shutter release button halfway down. Press the AE lock button to lock it. p.66
- 2 Check the viewfinder information, then press the shutter release button completely.

## ABOUT FOCUSING

The autofocus modes (AF.S/AF.C), manual focus mode, and focus point modes are explained here.

### USING AUTOFOCUS

The camera focuses automatically. There are two AF modes: AF Single (AF.S) mode which locks the focus while you press the shutter release button halfway, and AF Continuous (AF.C) mode which continues to focus while you press the shutter release button halfway down.



When the autofocus function or the viewfinder's focus indicator [ ● ] cannot be used for focus confirmation for the following reasons, focus on the subject in the manual focus mode with the aid of the matte field in the viewfinder as you would with a non-AF SLR camera. (p.76)

- The focus indicator [ ● ] is blinking. (The subject is difficult to autofocus.) (p.75)
- The maximum aperture of the lens in use is smaller than f/5.6.
- A bellows 100mm f/4 lens, Shift 28mm f/3.5 (shifted) lens, or Reflex lens is in use.
- An old type screw-mount lens fitted with an optional "Mount Adapter K".

### ◆ Using the AF Single mode (AF.S)

#### 1 Setting the AF Single mode (AF.S)

- 1 Slide the focus mode switch to [AF.S].

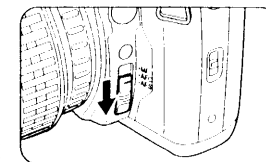

#### 2 Using the AF single mode (AF.S)

- 1 Frame the subject, then press the shutter release button halfway down. The camera focuses automatically, and when focus is achieved, the focus indicator [ ● ] lights and the audible PCV signal beeps.



- You can also autofocus with the AF button on the back cover.
  - While the focus indicator [ ● ] is lit, the focus will be locked (focus lock). If you want to focus another subject, first let go of the shutter release button to release the focus lock.
- 2 Check that the focus indicator [ ● ] is lit in the viewfinder, then press the shutter release button completely.



If the focus indicator [ ● ] blinks, it indicates that focus has not been achieved. In the AF Single mode (AF.S), you cannot take a picture while the subject is out of focus. If the subject is too close to the camera, move back and take the picture. If the camera has difficulty focusing the subject (p.75), focus manually.

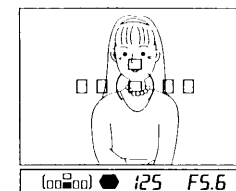

Focus indicator

## ◆ Using the AF Continuous mode (A.F.C)

### 1 Setting the AF Continuous Mode (A.F.C)

- 1 Slide the focus mode switch to [A.F.C].

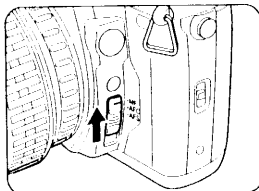

### 2 Using the AF Continuous mode (A.F.C)

- 1 Frame the subject, then press the shutter release button halfway down. The camera focuses automatically, and when focus is achieved, the focus indicator [●] lights and the audible PCV signal beeps.



In the AF Continuous mode (A.F.C) mode, the camera switches to the predictive AF mode automatically when a moving subject is detected. It then focuses the subject continuously.

- 2 Press the shutter release button completely.



In the AF Continuous mode (A.F.C) mode, the shutter can be released even when the subject is out of focus.



### HARD-TO-AUTOFOCUS SUBJECTS

The autofocus system is highly precise, but not perfect. Depending on the brightness, contrast, shape, and size of your subject, the autofocus system may not operate. In this situation, use the focus-lock technique (p.80) or set the focus mode switch to [MF] and use the manual focus mode to focus the lens on the subject with the aid of the matte field in the viewfinder (p.76).

Subjects which may fool the autofocus system include:

- Extremely low-contrast subjects such as a white wall in the autofocus frame.
- Subjects which don't reflect much light in the autofocus frame.
- Subjects with complex or detailed patterns.
- Subjects which are moving too fast.
- Multiple subjects in the foreground and background of the autofocus frame.
- Subjects positioned against reflected light or strong backlight or with extremely bright backgrounds.



### ■ Notes on accessories

The following conditions do not allow autofocusing or manual focusing with the focus indicator in the viewfinder. Use the manual focus mode to focus on the subject with the aid of the matte field surrounding the autofocus frame. (p.76)

- When using "Stereo Adapter".
- When using Extension Tubes or an Auto Bellows for close-up photography.
- When using an ordinary polarizing filter; the half mirror incorporated into the autofocus system reduces the effectiveness of the autofocus function when used in combination with an ordinary polarizing filter. Use a CIRCULAR POLARIZING FILTER for proper autofocus operation.

### ■ Note on the SMC Pentax SOFT 85mm/f2.8lens

When shooting at a distance closer than approx.1.5m(4.9ft), set the lens to a manual f-stop setting between f/2.8 and f/4.5. A smaller aperture (f/5.6 to f/32) may cause the autofocus system and the viewfinder's focus indicator to malfunction. To remedy this problem, temporarily set the lens to f/4.5. After focusing on the subject, lock focus, and set the lens to the required f-stop.

### **Memo** Using the snap-in focus function

When the subject comes to the point where the lens was pre-focused, the shutter is automatically released.

- ① Use a non-autofocus lens.
- ② Set the focus mode switch to [AF.S].
- ③ Focus at the point where you wish to capture the subject.
- ④ Using optional cable switch CS-105 or CS-130, keep the trigger button pressed so that the autofocus and metering systems stay active.  
The camera releases the shutter automatically when the subject comes into focus at the point selected.

### **Memo**

In this case, of the six focus points, the lower center point alone is effective.

## FOCUSING MANUALLY

When you focus manually, you can either look at the focus indicator [●] or the viewfinder's matte field to see if the subject is in focus.

### ◆ Using the focus indicator [●]

### **Memo**

If the maximum aperture of the attached lens is f/5.6 or larger (f/1.2 - f/5.6), you can use the focus indicator [●] as a guide to achieve focus. With slower lenses, you have to look at the viewfinder's matte screen.

## 1 Setting manual focus (MF)

- ① Slide the focus mode switch to [MF].

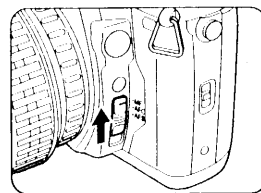

## 2 Focusing

- ① **Frame the subject, then press the shutter release button halfway down.**
- ② **Turn the focusing ring on the lens until the subject is focused.**  
When focus is achieved, the focus indicator [●] lights and the audible PCV signal beeps.
- ③ **Check that the focus indicator [●] is lit, then press the shutter release button completely.**

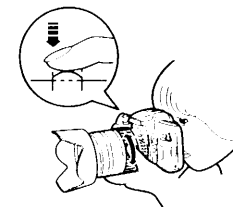

### ◆ Using the viewfinder's matte screen.

## 1 Setting manual focus (MF)

- ① Slide the focus mode switch to [MF].

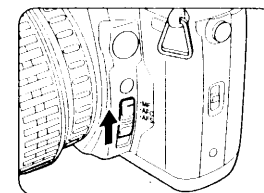

## 2 Focus the subject

- ① **Frame the subject, then turn the focusing ring on the lens until the subject is in focus.**  
Focus until the subject looks sharp in the viewfinder.
- ② **Check that the subject is in sharp focus, then press the shutter release button completely.**

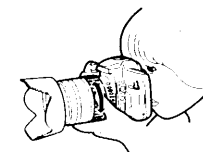



## SELECTING THE FOCUS POINT

There are six focus points in the viewfinder. If the focus point mode switch is set to automatic and the camera does not select the desired focus point, you can select the desired focus point manually.



- If the camera cannot focus using the desired focus point, it uses the neighboring point. You can use the Pentax Function to disable this capability so that the neighboring focus points are not used. (p.116)
- If you are using non-F or non-FA lenses, the lower center focus point is the only available point of the six focus points.

### 1 Selecting the focus point

- 1 Look through the viewfinder and check where you want to focus.



Which of the six focus points in the viewfinder is utilized for focusing can be identified by the lighted position in the focusing position indicator in the bottom of the viewfinder.

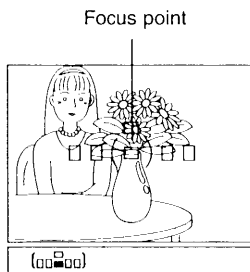

Focusing position in the viewfinder  
The person should be in focus, but the camera focuses the center of the picture instead.

- 2 Push up and hold the focus point mode switch to [SEL. ▲], then turn the select dial to select the desired focus point.

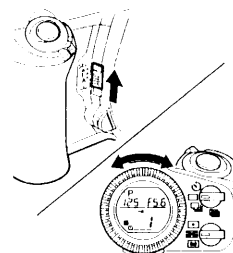

Focus point: The selected focus point lights

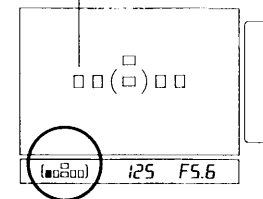

Focusing position in the viewfinder



To bring the focus point back to the center, press the exposure mode reset button while holding down the focus point mode switch up to the [SEL. ▲] position.

- 3 When you let go of the focus point mode switch, it will go back to the [L] position.

### 2 Aiming the focus point

- 1 Look through the viewfinder and aim the selected focus point over the subject.

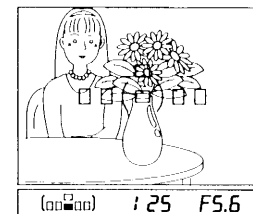

- 2 Press the shutter release button halfway down.  
The selected focus point will light in the viewfinder's focus point area, and the camera will focus at that point.
- 3 Press the shutter release button completely.

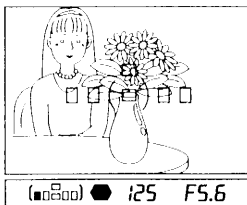

The person is focused.

### 3 Cancelling the selected focus point

- 1 Slide the focus point mode switch to [A].  
The selected focus point is cancelled, and the camera selects the focus point automatically.

## USING FOCUS LOCK

If the subject is not covered by any of the focus points, the camera cannot automatically focus on the subject. In this situation, you can aim the focus point on the subject, use focus lock, then recompose the picture.

### 1 Setting the autofocus mode

- 1 Slide the focus mode switch to [AF.S].



When you want to use focus lock, be sure to set the focus mode to the AF Single mode [AF.S].

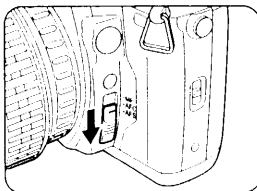

### 2 Using focus lock

- 1 Frame the subject. If the subject you want to focus is not on any of the focus points, you can use focus lock.

Figure to the right shows the person is not focused and the background is focused instead.

- 2 Aim the center of the viewfinder over the subject, then press the shutter release button halfway down.



- You can lock the focus by pressing the shutter release button halfway down or by pressing the AF button.
- While the focus indicator [●] is lit, the focus will be locked (focus lock).
- Rotating the zooming barrel in focus lock mode may cause the subject out of focus.

- 3 Check that the focus indicator [●] is lit in the viewfinder, then press the shutter release button completely.

#### The desired framing

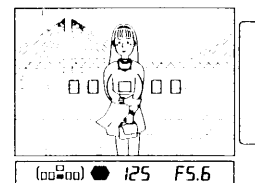
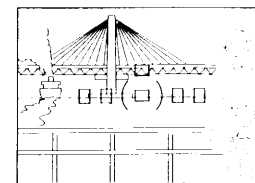

Aim the center of the viewfinder over the subject, then press the shutter release button halfway.

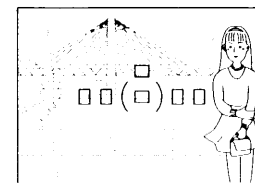

The person is focused.

## PREVIEWING THE DEPTH OF FIELD

Before shooting, you can preview the depth of field in the viewfinder.

### 1 Focusing the subject.

- 1 Bring focus to the subject.

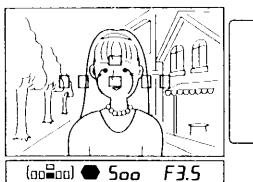

### 2 Previewing the depth of field

- 1 While looking through the viewfinder, turn the main switch from the [ON] position to the [ ] position. You can view the focused area in the viewfinder.



- While the main switch is in the [ ] position, no shooting information is displayed and the shutter cannot be released.
- The depth of field can be previewed in any exposure mode.
- The focus range display in the viewfinder may differ slightly from the actual picture.

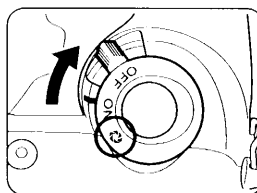

# FLASH PHOTOGRAPHY

|  |     |
|--|-----|
| USING THE BUILT-IN FLASH .....                           | 84  |
| SETTING THE FLASH MODE .....                             | 84  |
| ADVANCED TECHNIQUES WITH THE<br>BUILT-IN FLASH.....      | 87  |
| USING EXTERNAL FLASH .....                               | 91  |
| FLASH FEATURES .....                                     | 91  |
| USING P-TTL AUTO FLASH .....                             | 92  |
| USING HIGH-SPEED SYNC WITH THE<br>AF360FGZ.....          | 93  |
| WIRELESS FLASH .....                                     | 96  |
| USING BOTH THE BUILT-IN FLASH AND<br>EXTERNAL FLASH..... | 97  |
| USING CONTRAST-CONTROL-SYNC<br>FLASH MODE.....           | 99  |
| USING SLOW-SPEED SYNC .....                              | 101 |
| WHEN USING FLASH .....                                   | 103 |

# USING THE BUILT-IN FLASH

This section explains how to set the built-in flash modes and notes concerning the built-in flash.

## SETTING THE FLASH MODE

The following flash modes can be set:

**Flash ON mode:** The flash fires when you press the shutter release button. (p.30)

**Red-eye reduction mode:** To make the eye's iris smaller, a low-output flash fires right before the picture is taken. This is to reduce the chances of red eye from occurring in the subject's eyes.

**Automatic flash mode:** When the Programmed AE mode is also set, the built-in flash fires automatically under low-light or backlit conditions.



- When using the built-in flash, do not use a lens hood. Doing so will obstruct the flash coverage.
- An external flash can also be made to automatically fire.

### 1 Activating the built-in flash

① Check that the camera is turned on, then press the flash pop-up button.

The built-in flash will pop up and start charging automatically. When the [⚡] appears on the LCD panel and in the viewfinder, it indicates that the flash is ready to fire.

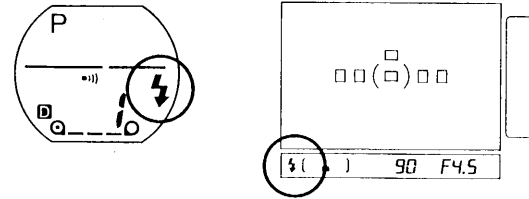
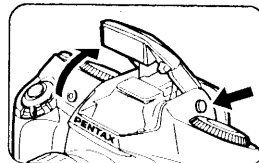

### 2 Setting the flash mode

① While pressing the flash-function button, turn the select dial.

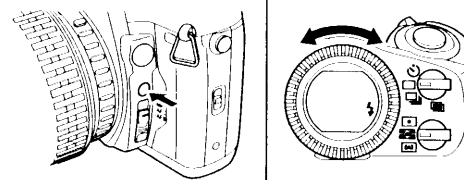

The flash mode will be displayed on the LCD panel as shown below.

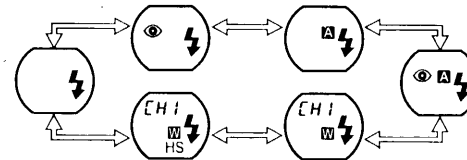

- Auto flashing [A] can only be selected in the Programmed AE mode.

**Memo** Flash mode display

The flash fires in accordance with the flash mode indicated on the LCD panel.

| Icon displayed | Flash mode                   | Flash status  |
|----------------|------------------------------|---|
|                | Flash ON                     | Flash fires when you press the shutter release button.  |
|                | Flash ON + Red-eye reduction | When the flash is fired in the flash ON mode, red-eye reduction takes effect.*1   |
|                | Automatic firing             | If the Programmed AE mode is set, the flash fires automatically when necessary. The flash fires automatically under the following conditions in the respective metering mode. *2<br><b>Multi-segment metering:</b><br>In low-light or backlit conditions<br><b>Center-weighted metering:</b><br>In low-light conditions only<br><b>Spot metering:</b><br>In low-light conditions only |
|                | Automatic firing + Red eye   | When the flash is fired in the automatic firing mode, red-eye reduction takes effect. *1, *2  |
|                | Wireless                     | Set when using a dedicated wireless flash.  p.96  |
|                | Wireless + high-speed sync   | Set when using high-speed sync with a dedicated wireless flash.  p.95   |

\*1: If red-eye reduction is used while the AF360FGZ, etc. is set as a slave unit, the preflash for red-eye reduction will trigger the slave unit to fire. When using a slave unit, do not use red-eye reduction.  
 \*2: The automatic flash mode will not work in any mode except Programmed AE. ( p.84).

**Memo** Reducing Red Eye

Red eye occurs in flash pictures when the flash reflects off the eye's retina. Although red eye cannot be totally prevented, it can be reduced by the following methods:

- Take the picture in a well-lit place.
- When using a zoom lens, use the wide-angle end and a close distance.
- If you are using an external flash unit, keep it apart from the camera lens as far as possible.

**ADVANCED TECHNIQUES WITH THE BUILT-IN FLASH**

This section explains how to calculate the built-in flash's effective range and the compatibility with F and FA lenses.

◆ **Calculating the flash effective distance according to the camera-to-subject distance.**

Calculate the effective flash range as follows:

**For far distances** Guide No. ÷ Current aperture

**For near distances** Far distance result ÷ 5\*1

\*1: This formula using "5" as the divider applies only to the built-in flash.

**Memo**

The flash cannot be used at distances shorter than 0.7 m. Doing so will result in irregular or obstructed flash coverage and flash overexposure.

The Guide No. will be as follows depending on the ISO film speed.

| ISO Film Speed | Guide No. |
|----------------|-----------|
| ISO25          | 6         |
| ISO50          | 8.5       |
| ISO100         | 12        |
| ISO200         | 17        |
| ISO400         | 24        |

With ISO 100 film and an f/2.8 aperture, calculate the effective flash range as follows:

**For far distances** Guide No.  $12 \div f/2.8 = \text{approx. } 4.3 \text{ m}$

**For near distances**  $4.3 \div 5 = \text{approx. } 0.9$

The effective flash range is therefore approx. 0.9 m - 4.3 m.

**Memo** **Calculating the flash aperture from the effective flash range**

Use the effective flash range to calculate the flash aperture as follows:

Guide No.  $\div$  flash range = Flash aperture

If the result is a number (such as 3) that is not a lens aperture value, set it to the next smaller aperture value (2.8).

**◆ F and FA Lens Compatibility with the Built-in Flash**

The compatibility of F and FA lenses with the built-in flash is explained here.

**Memo**

If an F or FA lens incompatible with the built-in flash is used, pressing the shutter release button when the flash is ready will have the [ ] blink on the LCD panel and in the viewfinder as a warning. (p.32)

If you take a flash picture with an incompatible lens, the corners of the picture may look dark or there may be a dark, semi-circular area on the lower part of the picture

**F and FA Lens Compatibility with the Built-in Flash**

○ = Compatible    △ = Vignetting will occur under the usage conditions  
 × = Incompatible because of vignetting

| Lens name                         | Compatibility   |
|-----------------------------------|---|
| F Zoom 17-28mm f/3.5-4.5          | ×   |
| FA Zoom 20-35mm f/4AL             | △<br>Vignetting will occur at focal length between 20-24mm.   |
| FA Zoom 24-90mm f/3.5-4.5AL (IF)  | △<br>Vignetting may occur if the focal length is 24-28mm.   |
| FA* Zoom 28-70mm f/2.8AL          | △<br>Vignetting may occur if the focal length is less than 35 mm or the camera-to-subject distance is closer than 1 m with the focal length of 40 mm. |
| FA Zoom 28-70mm f/4AL             | ○   |
| FA Zoom 28-80mm f/3.5-5.6         | ○   |
| FA Zoom 28-105mm f/3.2-4.5AL (IF) | ○   |
| FA Zoom 28-105mm f/4-5.6 (IF)     | ○   |
| FA Zoom 28-200mm f/3.8-5.6AL (IF) | △<br>Vignetting may occur if the focal length is 28 mm or the camera-to-subject distance is closer than 1 m with the focal length of 35 mm.           |



| Lens name                        | Compatibility |
|----------------------------------|---------------|
| F or FA Zoom 35-80mm f/4-5.6     | ○             |
| FA Zoom 70-200mm f/4-5.6         | ○             |
| FA* Zoom 80-200mm f/2.8 ED (IF)  | ○             |
| F or FA Zoom 80-200mm f/4.7-5.6  | ○             |
| FA Zoom 80-320mm f/4.5-5.6       | ○             |
| F or FA Zoom 100-300mm f/4.5-5.6 | ○             |
| FA Zoom 100-300mm f/4.7-5.8      | ○             |
| FA* Zoom 250-600mm f/5.6ED(IF)   | ×             |
| FA 20mm f/2.8                    | ×             |
| FA 24mm f/2 AL(IF)               | ×             |
| FA 28mm f/2.8                    | ○             |
| FA 31mm f/1.8 AL Limited         | ○             |
| FA 35mm f/2AL                    | ○             |
| FA 43mm f/1.9 Limited            | ○             |
| FA 50mm f/1.4, f/1.7             | ○             |
| FA 77mm f/1.8 Limited            | ○             |
| FA* 85mm f/1.4 (IF)              | ○             |
| FA 135mm f/2.8 (IF)              | ○             |
| FA* 200mm f/2.8 ED (IF)          | ○             |
| FA* 300mm f/2.8 ED (IF)          | ×             |
| FA* 300mm f/4.5 ED (IF)          | ○             |
| FA* 400mm f/5.6 ED (IF)          | ○             |
| FA* 600mm f/4 ED (IF)            | ×             |
| FA Macro 50mm f/2.8              | ○             |
| FA Macro 100mm f/2.8             | ○             |
| FA Macro 100mm f/3.5             | ○             |
| FA* Macro 200mm f/4.0 ED (IF)    | ○             |
| FA Soft 28mm f/2.8               | ○             |
| FA Soft 85mm f/2.8               | ○             |

## USING EXTERNAL FLASH

When the built-in flash cannot provide enough illumination, use a Pentax-dedicated, external flash unit (sold separately). With an external flash unit, you can use TTL auto flash, wireless flash (with the AF360FGZ), or high-speed sync.

### FLASH FEATURES

The features available with the built-in flash or a dedicated, external flash (sold separately) are described below. Check which type your external flash unit is and see which features it has.

| Camera Features   | TYPE A          | TYPE B | TYPE C | TYPE D | TYPE E          | TYPE F          |
|---|-----------------|--------|--------|--------|-----------------|-----------------|
| Red-eye reduction   | ○               | ○      | ○      | ×      | ○ <sup>*1</sup> | ×               |
| Automatic firing of the flash   | ○               | ○      | ○      | ○      | ○               | ○               |
| When the flash is ready, the camera switches to the flash sync speed automatically.                       | ○               | ○      | ○      | ○      | ○               | ○               |
| In the Programmed AE or Shutter-Priority AE mode, the aperture is set automatically.                      | ○               | ○      | ○      | ○      | ○ <sup>*2</sup> | ○ <sup>*2</sup> |
| Flash confirmation in the viewfinder  | ×               | ○      | ○      | ○      | ×               | ×               |
| TTL auto flash  p.92   | ○               | ○      | ○      | ○      | ○ <sup>*3</sup> | ×               |
| P-TTL auto flash  p.92 | ×               | ○      | ×      | ×      | ×               | ×               |
| Slow-speed sync  p.101 | ○               | ○      | ○      | ○      | ○               | ○               |
| AF illuminator  | ○               | ○      | ○      | ○      | ×               | ×               |
| Trailing shutter curtain sync flash <sup>*4</sup>   | ○ <sup>*5</sup> | ○      | ○      | ○      | ×               | ×               |
| Contrast-control-sync flash mode <sup>*6</sup>  | ×               | ○      | ○      | ×      | ×               | ×               |
| Multiple-burst flash, slave flash   | ×               | ○      | ○      | ×      | ×               | ×               |
| High-speed sync   | ×               | ○      | ×      | ×      | ×               | ×               |
| Wireless flash  | ×               | ○      | ×      | ×      | ×               | ×               |

TYPE A: Built-in flash  
 TYPE B: AF360FGZ  
 TYPE C: AF500FTZ, AF330FTZ  
 TYPE D: AF400FTZ, AF240FTZ  
 TYPE E: AF400T, AF280T, AF220T, AF200T, AF080C, AF140C, AF201SA  
 TYPE F: AF200S, AF160, AF140

- \*1: Available with the AF280T and AF400T, only when the flash confirmation indicator in the viewfinder is off and TTL auto is set.
- \*2: With Type E flash units (except AF201SA), use the MS (Manual Sync) or M (Manual) mode. With Type F flash units, use Aperture-Priority AE, manual, or bulb. Programmed AE and Shutter-Priority AE cannot be used because the aperture changes.
- \*3: With the AF201SA, TTL auto cannot be used.
- \*4: The shutter speed will be 1/90 sec. or slower.
- \*5: With Type B or C, and D flash units, trailing shutter curtain sync flash is possible.
- \*6: The shutter speed will be 1/60 sec. or slower.

## USING TTL AUTO FLASH

P-TTL auto flash, which pre-fires the flash using the six-segment metering, allows more precise control.

P-TTL is available with external wireless flash.



P-TTL auto flash is only available in combination with the AF360FGZ.

### 1 Attaching the Flash

- ① Remove the hot shoe cover FL from the camera.



Put the hot shoe cover in the strap's pocket. p.12

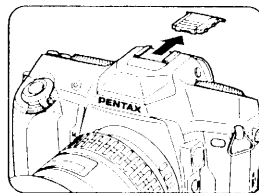

- ② Attach the flash unit.

### 2 Set it to the TTL auto mode

- ① Turn on the flash unit's power switch.
- ② Set the flash unit's firing mode to TTL auto.



- With the AF360FGZ, the flash mode is always set to P-TTL auto; with any other flash unit, it is set to TTL auto.
- For instructions on how to operate the flash unit, refer to the flash unit's operating manual.

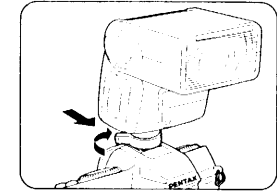

### 3 Taking a Flash Picture

- ① Check that the flash is ready.
- ② Focus the subject and take the picture.



- When the flash is ready (fully charged), the [ ] will light in the viewfinder when you press the shutter release button halfway down.
- An external flash can also be made to automatically fire. Note that the flash will not fire against a lighter subject especially during daytime sync shooting.

## USING HIGH-SPEED SYNC

With the AF360FGZ, you can use a flash sync speed faster than 1/180 sec. You can use high-speed sync while the flash unit is attached to the camera or in a wireless configuration.

With high-speed sync.





## ◆ Using On-Camera Flash

### 1 Attaching the Flash Unit

- 1 Remove Hot Shoe Cover FL from the camera.



Store the Hot Shoe Cover in the strap's pocket. p.12

- 2 Attach the flash unit.

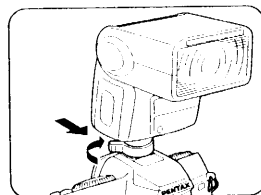
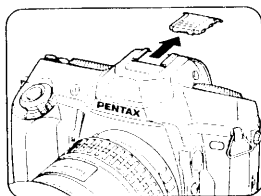

### 2 Set the flash unit to the HS mode.

- 1 Set the flash unit's firing mode to HS (high-speed sync).



For instructions on how to operate the flash unit, refer to the flash unit's operating manual.

### 3 Using High-speed sync.

- 1 Check that the flash is ready.
- 2 Focus the subject and take the picture.



- When the flash is ready (fully charged), the will light in the viewfinder when you press the shutter release button halfway down.
- The high-speed sync is only available when the shutter speed is faster than 1/180 sec.

## ◆ Using Wireless Flash

### 1 Positioning the Flash

- 1 Place the flash unit where you want the flash to fire.
- 2 Set the flash unit's power switch to [WIRELESS].
- 3 Set the flash unit's sync mode to HS (high-speed sync).
- 4 Set the wireless mode to S (Slave).



For instructions on how to operate the flash unit, refer to the flash unit's operating manual.

### 2 Set the camera to the HS mode.

- 1 Press the flash pop-up button to enable the built-in flash to be used.
- 2 While pressing the flash function button, turn the select dial until HS is displayed.

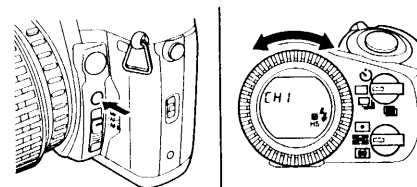

- 3 Check that both the built-in flash and external flash unit are ready.
- 4 Focus the subject and take the picture.



- When the built-in flash is ready (fully charged), the will light in the viewfinder when you press the shutter release button halfway down.
- The high-speed sync is only available when the shutter speed is faster than 1/180 sec.

## WIRELESS FLASH

With the AF360FGZ, you can fire a flash without having a cord connection between the camera and flash unit. The high-speed sync mode can also be used with wireless flash.  p.93

### 1 Positioning the Flash

- 1 Place the flash unit where you want the flash to fire.
- 2 Set the flash unit's power switch to [WIRELESS].
- 3 Set the wireless mode to S (Slave).



For instructions on how to operate the flash unit, refer to the flash unit's operating manual.

### 2 Set the camera to the wireless mode.

- 1 Press the flash pop-up button to enable the built-in flash to be used.
- 2 While pressing the flash function button, turn the select dial until [W] is displayed.

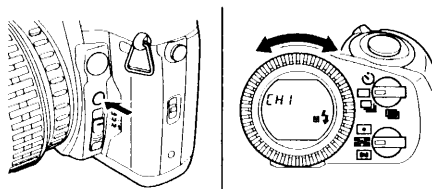

- 3 Check that both the built-in flash and external flash unit are ready.
- 4 Focus the subject and take the picture.



When the built-in flash is ready (fully charged), the  will light in the viewfinder when you press the shutter release button halfway down.



#### Wireless Flash Control (P-TTL flash mode)

When the AF360FGZ is used for wireless flash, the following process is executed between the built-in flash and AF360FGZ before the flash is fired.

- 1 You press the shutter release button completely.
- 2 The built-in flash fires a preflash (the camera's firing mode is transmitted).
- 3 The external flash unit fires a preflash (the subject's lighting condition is checked).
- 4 The built-in flash fires a preflash (the required flash output is transmitted to the external flash).
  - \* If HS (high-speed sync) has also been set, the built-in flash will fire another preflash to transmit the flash duration.
- 5 The external flash unit fires the flash.



Using the Pentax Function No.10, you can select how the built-in flash is to be used: either as a means of information controller to the external flash or as a flash to affect the exposure.



#### Channel Control

For wireless control, channel (e.g. CH1) for the AF360FGZ must be set on the camera. You can do that by attaching the AF360FGZ to the camera, turning on the camera and pressing the shutter release button halfway down.

## USING BOTH THE BUILT-IN FLASH AND EXTERNAL FLASH

To use both the built-in flash and external flash simultaneously, follow the procedure below.

To use both the built-in flash and a dedicated external flash simultaneously, the following accessories (sold separately) are required.

Hot Shoe Adapter FG, Off-Camera Shoe Adapter F, Extension Cord F5P

# 1 Attaching a Flash Unit

- 1 Remove Hot Shoe Cover FL from the camera.



Put the hot shoe cover in the strap's pocket. p.12

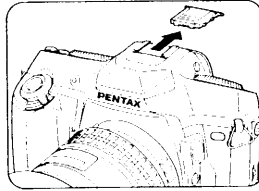

- 2 Attach Hot Shoe Adapter Fg to the camera.
- 3 Connect Extension Cord F5P to the Hot Shoe Adapter.
- 4 Attach Off-Camera Shoe Adapter F to a tripod.
- 5 Connect Extension Cord F5P to the Off-Camera Shoe Adapter.
- 6 Attaching a Flash Unit to the Off-Camera Shoe Adapter.
- 7 Press the flash pop-up button.



The AF500FTZ can be connected directly to Extension Cord F5P without requiring Off-Camera Shoe Adapter F

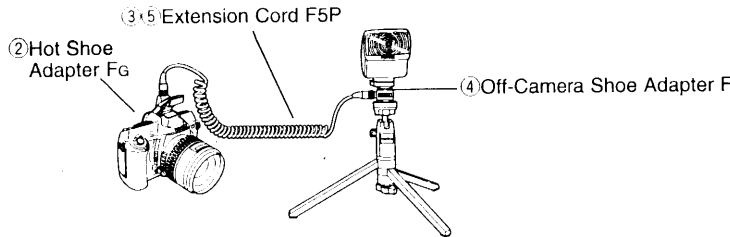

### • Using multiple external flashes

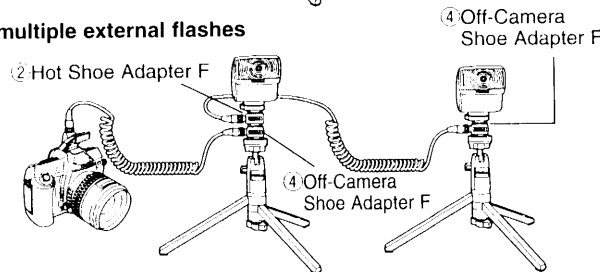

# USING CONTRAST-CONTROL-SYNC FLASH MODE

Using the dedicated external flash in combination with the built-in flash allows twin flash photography (contrast-control-synch flash photography). This is based on the difference between the amount of light discharged from two units.



Contrast-control-synch flash is possible with the following flash units: AF360FGZ or AF330FTZ, AF500FTZ, and the built-in flash.

## ◆ Using the built-in flash and a dedicated external flash.

# 1 Attaching a Flash Unit

- 1 Place the flash unit apart from the camera.



Do not use accessories (such a hot shoe grip) having a different number of contacts. Doing so may cause misoperation.

- 2 Set the flash unit's sync mode to Contrast-Control-Synch Flash Mode.



For instructions on how to set the sync mode, refer to the flash unit's operating manual.

# 2 Take the picture.

- 1 Press the flash pop-up button to enable the built-in flash to be used.
- 2 Check that the flash is ready.
- 3 Focus the subject and take the picture.



- Between the built-in flash and external flash, the flash ratio will be 1:2 respectively (summed up when the external flashes are more than one).
- When the contrast-control-sync flash mode is used, the maximum flash sync speed will be 1/60 sec.

## ◆ Using Multiple External Flash Units (with no built-in flash)

### 1 Ready the Flash Units

- ① Set up the external flash units separated from the camera.



A hot shoe grip, if used, would cause the TTL metering to function improperly. For instructions for connection, see p.98.

- ② Set the required flash units' sync mode to Contrast-Control-Sync Flash mode.



Output ratio of the flash is 2 for contrast-control-sync mode to 1 for the other flash mode.

For instructions on how to set the contrast-control-sync mode, see the flashunit's operating manual.

### 2 Take the picture.

- ① Check that charging is finished with all the flash units.
- ② Focus the subject and take the picture.



#### External multiple sync flashes

Note the following when you use two or more flashes in sync.

- Use the flashes in the following combinations referring to the "Flash Features" ( p.91).
  - Combine the same type (Type B to F) of flashes.
  - If you use different type combination of flashes, combine Type C and Type D or Type E and Type F.
- You can use any type of combinations of the built-in flashes.

## USING SLOW-SPEED SYNC

When you photograph someone in front of a sunset or dark background, using slow-speed sync flash will result in the proper exposure of both the subject and background. Slow-speed sync can be set with the built-in flash or with any dedicated external flash unit.



With slow-speed sync, a slow shutter speed is used. To prevent camera shake, use a tripod.

## ◆ Using Metered Manual Mode

### 1 Ready the Flash

- ① If you will use the built-in flash, press the flash pop-up button.



If you will use an external flash, turn on the power.

### 2 Setting the Metered Manual Mode

- ① Hold down the lens aperture-A lock button and turn the aperture ring to set the aperture.
- ② Turn the select dial to set the shutter speed. p.62.  
The LCD panel will show "M" (Manual) for the shutter speed.



Check that the flash is ready and that the flash exposure setting is correct.

- ③ Focus the subject and take the picture.

## ◆ Using Shutter-Priority AE

### 1 Setting the Shutter-Priority AE Mode

- ① Hold down the lens aperture-A lock button and turn the aperture ring to [A].
- ② Turn the select dial to set the shutter speed.

### 2 Ready the Flash



Do not ready the flash before setting the shutter speed. First set the shutter speed, then ready the flash. Otherwise, the background will not be exposed properly.

- ① If you will use the built-in flash, press the flash pop-up button.



If you will use an external flash, turn on the power.

### 3 Focus the subject and take the picture.

## WHEN USING FLASH

Cautions for using flash are explained below.

### ◆ Using the built-in flash and a dedicated external flash

- If you use the built-in flash and a Pentax-dedicated external flash simultaneously and set the external flash to trailing shutter curtain sync, the built-in flash will also be set to trailing shutter curtain sync.
- Before taking the picture, make sure both the built-in flash and external flash are ready (fully charged).

### ◆ Using a non-Pentax flash unit

- Using a non-Pentax flash unit may cause a malfunction. Pentax-dedicated flash units are recommended.
- When using studio type flash with the camera, note the polarity of the flash contacts. Some studio type flash units may have reversed polarity which will not work with the camera. For details, consult the manufacturer of the flash.
- When using studio type flash, set a flash sync speed one stop slower than the camera's normal sync speed. This is to prevent a partial flash exposure (part of the picture looks dark).

# APPENDIX

|                                  |     |
|----------------------------------|-----|
| PENTAX FUNCTIONS .....           | 106 |
| SETTING PENTAX FUNCTIONS.....    | 108 |
| SETTING A PENTAX FUNCTIONS ..... | 110 |
| ACCESSORIES (OPTIONAL) .....     | 123 |
| TROUBLE SHOOTING .....           | 128 |
| SPECIFICATIONS.....              | 132 |
| WARRANTY POLICY .....            | 136 |

# PENTAX FUNCTIONS

The camera provides 19 Pentax Functions so you can set the camera according to your shooting preferences.

## ● Audible PCV Signal Function

[F1] Enabling/disabling the audible PCV signal  p.110

## ● Exposure Functions

[F2] Setting the exposure program line either Normal, Shutter Speed-Priority, Depth of Field-Priority or MTF-Priority Program Line.  p.111

[F3] Setting the number of auto bracketing exposures  p.113

[F4] Setting the auto bracketing sequence  p.114

[F5] During multi-segment metering, the autoexposure reading can be taken or not taken at the point where autofocus is achieved  p.114

[F6] Setting the AF button to only focus or to both focus and obtain an exposure reading  p.115

[F7] Setting the ISO film speed automatically or manually  p.115

## ● Autofocus Functions

[F8] If you cannot focus on the desired focus point, you can select whether you use a neighboring focus point.  p.116

## ● Flash Functions

[F9] Enabling/disabling shutter release before the built-in flash is ready  p.116

[F10] Setting the built-in flash as a flash or wireless controller in the wireless mode  p.117

[F11] Setting the firing method when using the illumination button with the AF360FGZ in the wireless mode  p.117

## ● Film Rewind Functions

[F12] Setting the film rewind to rewind completely or to leave out the film leader or to leave out the film leader and enable MRC frame advance  p.118

[F13] Setting the film rewind method (automatic or manual) at the end of the roll  p.119

## ● Self-timer Functions

[F14] Setting the self-timer delay to 12 sec. or 2 sec. (with mirror lock-up)  p.119

## ● Data Imprinting Functions

[F15] Setting the film speed for imprinting data  p.120

## ● Button and Dial Settings

[F16] Focusing with or without the shutter button pressed halfway down.  p.120

[F17] Setting the select dial's rotating orientation for advancing the numeric value  p.121

## ● Lens Mount Index Lamp Function

[F18] Enabling or disabling the lens mount index lamp  p.121

## ● Remote Control Functions

[F19] With the optional battery grip BG-10 attached, setting the remote control button to release the shutter in 3 sec. or immediately (Remote controller for shutter release is optional.)  p.122

## SETTING PENTAX FUNCTIONS

Follow the procedure below to set a Pentax Function.

### 1 Display Pentax Function No.1.

- Hold down the lock release button and turn the exposure compensation dial to PF. "PF" will be displayed on the LCD panel.

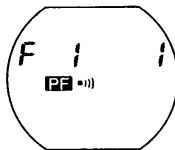
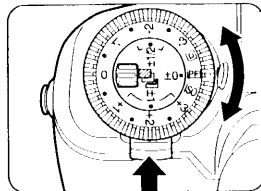

- Turn the select dial to display the Pentax Function No. you want to set. The Pentax Function No. will be displayed on the LCD panel.

**Example:**  
Setting the number of auto bracketing exposures.

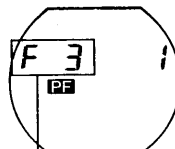

Pentax Function No.

### 2 Display the setting No.

- Press the AE lock button and display the setting No. The setting No. will be displayed on the LCD panel.



The LCD panel shows that Pentax Function No. F3 (number of auto bracketing exposures) has been selected and setting No. 2 (two auto bracketing exposures) has been set.

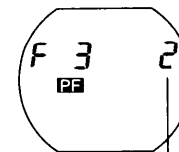
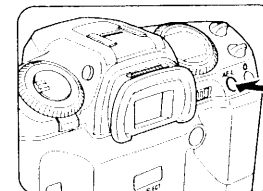

Setting No.

- Hold down the lock release button and turn the exposure compensation dial to "0".



If your configuration in the Pentax Function is different from the default values, "PF" will be displayed on the LCD panel.



#### Resetting the Pentax Functions to the Default Settings

To reset all the Pentax Functions to the default settings, follow the procedure below.

- Hold down the lock release button and turn the exposure compensation dial to PF.

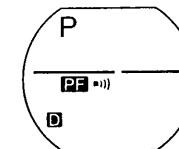



- ② Hold down the exposure mode button for 2 sec. or longer. "CL" will be displayed on the LCD panel, and all the Pentax Functions will be reset to the default settings.
- ③ Hold down the lock release button and turn the exposure compensation dial to "0".

"PF" will disappear from the LCD panel to indicate that no Pentax Functions have been set.

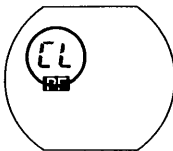

## SETTING A PENTAX FUNCTION

The settings for each Pentax Function are explained below. To display the Pentax Function No. and setting No., see "Setting Pentax Functions."

- ① Turn the exposure compensation dial to PF

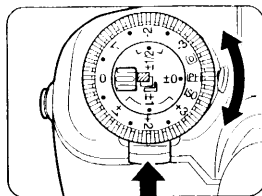

- ② Pentax Function No.: Select with the select dial.

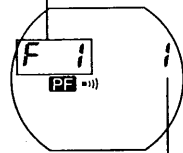

- ③ Setting No.: Select with the AE lock button.

### ◆ [F1] Enabling/disabling the audible PCV signal

The audible PCV signal's beeping can be enabled or silenced when focus is achieved or an error occurs or film count reaches 30 as film depletion warning.

- Pentax Function No. F1
  - Setting No.
- [1]...Enables the audible PCV signal.
  - [2]...Disables the audible PCV signal.

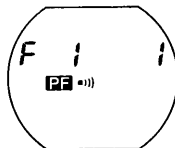

### ◆ [F2] Setting the exposure program line

You can alter the exposure program line so that a faster shutter speed or a smaller aperture is set than when the normal program line is used. This enables you to set the optimum exposure suiting the performance of your FA lens.

- Pentax Function No. F2
- Setting No.

- [1]...Sets the normal program exposure.
- [2]...Sets a faster shutter speed (Shutter Speed-Priority Program Line).
- [3]...Sets a smaller aperture (Depth of Field-Priority Program Line).
- [4]...Matches the FA lens performance (MTF-Priority Program Line).

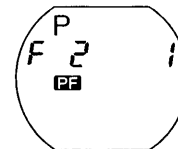

\*The program line differs depending on the lens, and this information is recorded in the FA lens.



Various program lines for FA24-90 mm lens are shown below.

#### [1] Normal Program Line

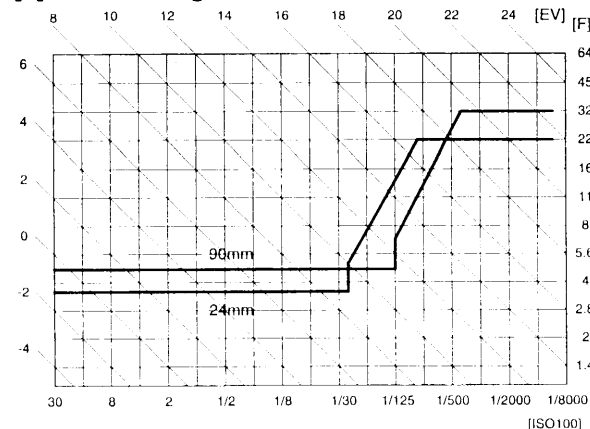

FA24-90mm F3.5-4.5

### [2] Shutter Speed-Priority Program Line

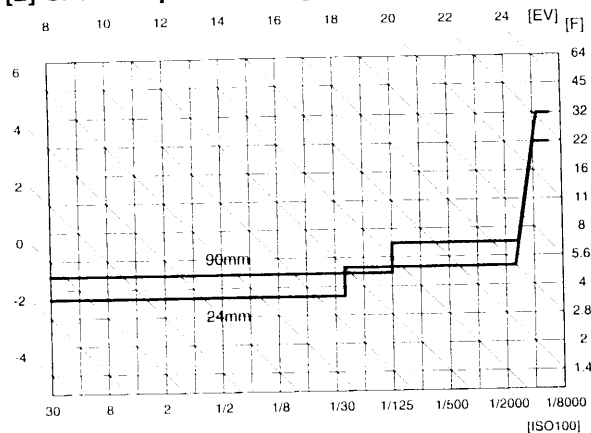

FA24-90mm F3.5-4.5

### [3] Depth of Field-Priority Program Line

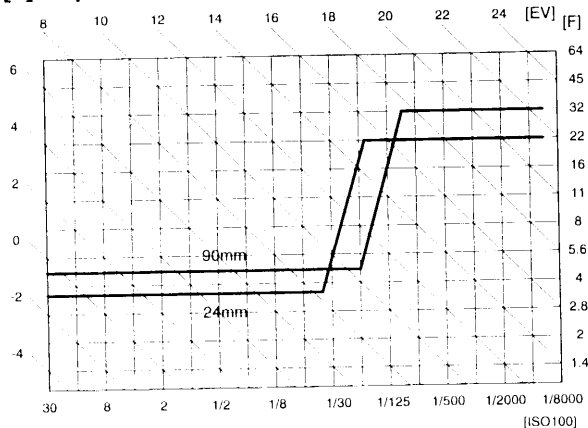

FA24-90mm F3.5-4.5

### [4] MTF-Priority Program Line

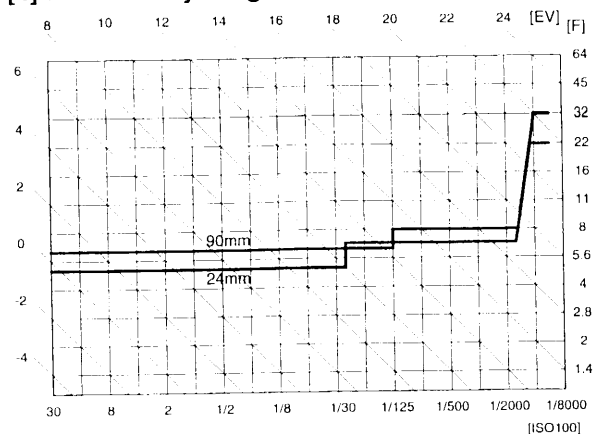

FA24-90mm F3.5-4.5

### ◆ [F3] Setting the number of auto bracketing exposures

You can set the number of auto bracketing exposures.

● Pentax Function No. [F3]

● Setting No.

[1]...3 exposures (correct exposure, under exposure, and over exposure).

[2]...2 exposures (correct exposure and under exposure).

[3]...5 exposures (correct exposure, one and two stops under exposure, and one and two stops over exposure).



- The auto bracketing sequence will depend on the Pentax Function No. [F4] setting.

### ◆ [F4] Setting the auto bracketing sequence

You can set the sequence of the auto bracketing exposures.

● Pentax Function No. [F4]

● Setting No.

| Setting No | 3 bracketed exposures | 2 bracketed exposures | 5 bracketed exposures |
|------------|-----------------------|-----------------------|-----------------------|
| [1]        | [±0]→[-]→[+]          | [±0]→[-]              | [±0]→[-]→[+]→[-]→[+]  |
| [2]        | [-]→[±0]→[+]          | [-]→[±0]              | [-]→[-]→[±0]→[+]→[+]  |
| [3]        | [+]→[±0]→[-]          | [+]→[±0]              | [+ ]→[+]→[±0]→[-]→[-] |

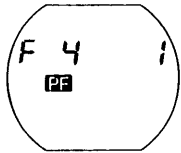

- The number of bracketed exposures will depend on the Pentax Function No. [F3] setting.
- In the above table, [±0] indicates no bracketing, [-] indicates under exposure by 1 stop, [- -] indicates under exposure by 2 stops, [+] indicates over exposure by 1 stop, and [+ +] indicates over exposure by 2 stops.

### ◆ [F5] Linking AF and AE at the focus point

During multi-segment metering, the autoexposure (AE) reading can be taken or not taken at the point where autofocus is achieved.

● Pentax Function No. [F5]

● Setting No.

[1]...Executes autofocus only (no autoexposure reading).

[2]...Executes both autofocus and autoexposure.

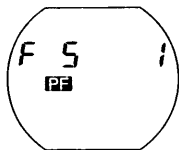

### ◆ [F6] Setting both autofocus and autoexposure metering with the AF button

When you press the AF button, you can autofocus only or autofocus and lock the autoexposure reading at the same time.

● Pentax Function No. [F6]

● Setting No.

[1]...Autofocus only (no AE lock).

[2]...Autofocus and AE lock at the same time.

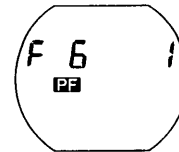

### ◆ [F7] Film speed setting method

The film speed of the DX-coded film can be set automatically or manually.

● Pentax Function No. [F7]

● Setting No.

[1]...Sets the film speed automatically.

[2]...You set the film speed manually.  p.36

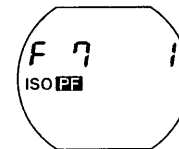

### ◆ [F8] Determining the focusing state in the focusing position

If you cannot focus on the desired focus point, you can select whether you use a neighboring focus point.

- Pentax Function No. [F8]
- Setting No.

- [1]...Use a focus point contiguous to the default focus point.
- [2]...Do not use a focus point contiguous to the default focus point.

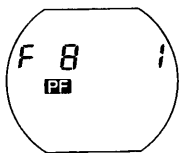

### ◆ [F9] Enabling shutter release before the built-in flash is ready

The shutter release button can be enabled or disabled to take a picture before the built-in flash is ready to fire.

- Pentax Function No. [F9]
- Setting No.

- [1]...Disables the shutter release button from taking a picture before the flash is ready.
- [2]...Enables the shutter release button to take a picture before the flash is ready.

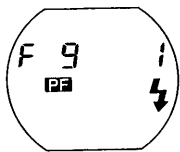

### ◆ [F 10] Setting the built-in flash's function during wireless operation

During wireless operation, you can set the built-in flash to function as a flash or wireless controller.

- Pentax Function No. [F10]
- Setting No.

- [1]...Sets the built-in flash to operate as a flash.
- [2]...Sets the built-in flash as a wireless flash controller.

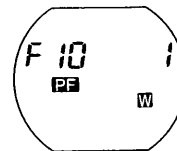

If the built-in flash is used as a wireless flash controller, the pre-flash emitted by the built-in flash unit does not affect the exposure, only to transmit the exposure information to the wireless flash.

### ◆ [F 11] Setting the illumination button's function during wireless operation

With the AF360FGZ attached to the camera or during wireless flash operation, the illumination button can be set to fire a test flash or modeling flash, the illumination button can be set to fire a test flash or modeling flash.

- Pentax Function No. [F11]
- Setting No.

- [1]...Disable the flash to fire.
- [2]...Sets the illumination button to fire a test flash.
- [3]...Sets the illumination button to fire a modeling flash.

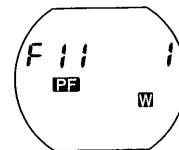

## ◆ [F12] Setting the film rewind mode

When the film is rewound, the film leader can be rewound into the cartridge or left out. Or, the film leader can be left out with the MRC frame advance function enabled.

● Pentax Function No. [F12]

● Setting No.

[1]...Rewinds the film completely.

[2]...Leaves out the film leader.

[3]...Leaves out the film leader and enables MRC frame advance.

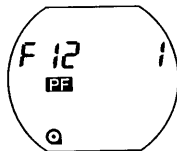

### **Memo** About MRC frame advance

With MRC frame advance (setting No. 3), a partially exposed roll of film can be rewound and loaded again. The camera will then automatically advance the film to the specified frame.

① For Pentax Function No. [F12], use setting No. 3.

② Rewind the partially exposed roll of film and remove it from the camera. (p.35)

\* Before rewinding the film, be sure to remember the current frame No. on the LCD panel.

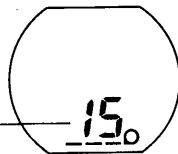

Number of exposures

③ Take pictures with another roll of film.

④ If you want to use the partially exposed film again, open the back cover and turn the select dial while pressing the exposure mode button to display the number of exposures.

\* To prevent double exposure, forward the film by a couple of extra frames by showing the additional number on the LCD panel.

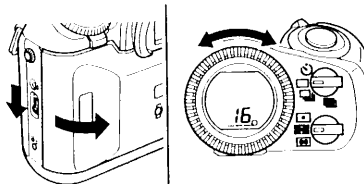

⑤ Load the partially exposed film into the camera.

The film will then advance to the frame No. specified with the select dial.

## ◆ [F13] Setting the film rewind method

At the end of the roll, the film can be rewound automatically or manually.

● Pentax Function No. [F13]

● Setting No.

[1]...Automatic film rewind at the end of the roll.

[2]...Disables automatic film rewind. (p.35)

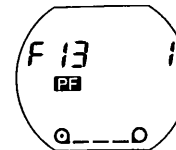

\* Press the mid-roll rewind button to rewind the film.

## ◆ [F14] Setting the self-timer delay time

The self-timer delay time can be set to 12 sec. or 2 sec. (with mirror lock-up).

● Pentax Function No. [F14]

● Setting No.

[1]...Self-timer delay of 12 sec.

[2]...Self-timer delay of 2 sec. with mirror lock-up.

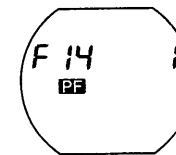

### **Memo** About mirror lock-up

During normal picture-taking, the shutter's reflex mirror goes up and creates a slight vibration. With mirror lock-up, the reflex mirror stays up before the exposure starts. This reduces camera shake caused by the mirror's movement. To set mirror lock-up, follow the procedure below:

① Set Pentax Function No. [F14] and setting No. 2.

② Set the drive switch to [S].

③ Focus the subject and press the shutter release button.

After the reflex mirror locks up, the picture will be taken 2 sec. later.

AE lock is enabled with the exposure value immediately before mirror lock-up.

### ◆ [F15] Setting the film speed for imprinting data

You can set the film speed for the data to be imprinted on the film.

- Pentax Function No. [F15]
- Setting No.

- [1]...Sets the film speed automatically according to the film's DX code.
- [2]...Low imprint density (for high-speed film)
- [3]...Medium imprint density
- [4]...High imprint density (for low-speed film)

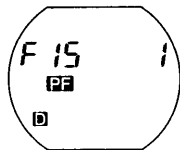

Level 4 provides the highest density imprinting.

### ◆ [F16] Enabling or disabling the focusing with the shutter release button pressed halfway down

You can set the shutter release button to lock the exposure only or to obtain both the exposure and focus when pressed halfway down.

- Pentax Function No. [F16]
- Setting No.

- [1]...Focusing with the shutter button pressed halfway down.
- [2]...Focusing without the shutter button pressed halfway down.

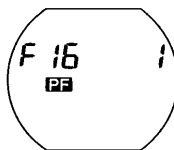

When this function is set to [2], focus the subject using the AF button; pressing the shutter release button halfway down will not perform focusing. Leaving the AF button off, your finger will trigger the shutter even if the subject is out of focus. Blurred pictures may result.

### ◆ [F17] Setting the select dial's rotating orientation

You can set the select dial to advance the numeric value by clockwise or counterclockwise rotation.

- Pentax Function No. [F17]
- Setting No.

- [1]...The numeric value advances with counterclockwise rotation.
- [2]...The numeric value advances with clockwise rotation.



### ◆ [F18] Enabling/disabling the lens mount index lamp

You can set the lens mount index lamp to light up when the lens unlock button is pressed.

- Pentax Function No. [F18]
- Setting No.

- [1]...Sets the lens mount index lamp to light.
- [2]...The lens mount index lamp does not light.

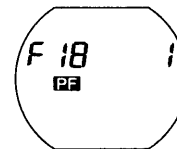

If you use the mount adapter K, set this function to [2] because the lens mount index lamp remains turned on.

## ◆ [F19] Setting the remote control button's shutter release time

Pressing the remote control button takes the picture 3 sec. later or immediately.

- Pentax Function No. [F19]
- Setting No.
- [1]...Shutter release after 3 sec.
- [2]...Immediate shutter release.

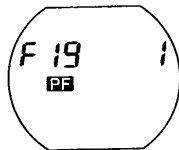

If you use remote control, optionally available Battery Grip BG-10 and the Remote Control Unit are required.

## ACCESSORIES (OPTIONAL)

A number of dedicated accessories are available for this camera.

### ■ BATTERY GRIP BG-10

Battery grip powered by size-AA batteries and dedicated to the MZ-S. A vertical-grip shutter release button is also provided for easier operation.

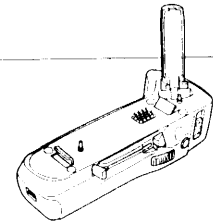

### ■ CABLE SWITCHES

#### Cable Switch CS-105/CS-130

Shutter release cable dedicated to the MZ-S. It comes in two lengths: 0.5 m (CS-105) and 3 m (CS-130).



#### Release Timer Switch TS-110

MZ-S-dedicated shutter release cable for interval and timer shooting.

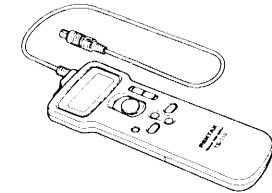

### ■ FLASH ACCESSORIES

#### AF360FGZ

TTL auto flash unit with Guide No. 36. Features include slave-sync flash, multiple-flash burst, contrast-control-sync flash, and leading/trailing curtain-sync flash. Together with the MZ-S, high-speed sync and wireless flash can be used.

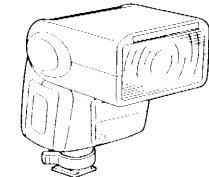

**AF500FTZ**

A TTL Auto Zoom flash with a built-in AF spotbeam and large guide number of 50 in meters (ISO 100). It features the slave sync flash function, multiple flash burst, contrast-control-sync flash, leading/trailing -curtain-sync flash mode.

**AF330FTZ**

A TTL Auto Zoom flash with a built-in AF spotbeam and large guide number of 33 in meters (ISO 100). It features the contrast-control-sync flash, leading/trailing -curtain-sync flash mode.

**AF220T**

A TTL Auto flash with a guide number of 22 in meters (ISO 100).

**AF201SA**

An auto flash (not TTL) with the guide number of 20 in meters (ISO 100).

**AF140C**

TTL macro flash unit with the guide number of 14 in meters (ISO 100).

**Off-Camera Shoe Clip CL-10**

Enables the AF360FGZ to be used as a wireless flash.

**Hot Shoe Adapter F, Extension Cord F5P and Off-Camera-Shoe Adapter**

The adapters and cord which allow the external flash to be used off the camera, while maintaining full electric coupling to the camera.

**VIEWFINDER, LENS AND CLOSE-UP ACCESSORIES****Magnifier FB**

Magnifies the image at the center of the viewfinder.

**Refconverter A**

Right angle finder which attaches to the grooves on both sides of the viewfinder. The viewfinder magnification is able to switch from 1X to 2X.



While attached, it may obstruct the opening/closing of the camera back. First detach the Refconverter A before opening/closing the camera back.

**AF Adapter 1.7X**

An adapter for autofocus photography using a non-autofocus lens with a maximum aperture of f/2.8 or larger.

**Filters**

Skylight, Cloudy, UV, Y2, O2, R2 and Circular Polarizing Filter are available in sizes of 49mm, 52mm, 67mm and 77mm.



- Since the camera's autofocus mechanism uses a semi-transparent mirror, using a non-circular polarizing filter may throw off the autofocus-ing and exposure metering precision. When using autofocus, a circular polarizing filter is recommended instead. This will also maintain exposure metering precision.
- When you attach/detach Adapter K (for the 645 lens) to the camera, the adapter's screw should not contact the camera body. If necessary, change the screw's position.

**Auto Extension Tube K**

A set of three tubes. A close-up accessory placed between camera and lens. Supports automatic aperture and metering with maximum aperture.



Note that Auto bellows A cannot be used with this camera because it cannot be fitted to it.

APPENDIX



## ■ CAMERA CASE CF-10

The soft case for MZ-S is available as an option and consists of a front and a back cover.

- 1 Fasten the back cover to the camera body by tightening the fitting screw in the tripod socket.

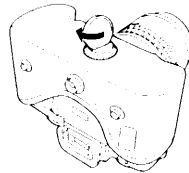

- 2 Attach the front case.

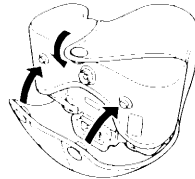

Front case comes in three sizes of S, M and L. Choose one according to your lens being used.

## ■ INTERCHANGEABLE FOCUSING SCREEN

The focusing screens are available as an option for this camera

### GF-60 (Matte field with autofocus frame)

Useful for general photography.

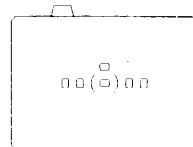

### GG-60 (Matte field with cross hairs)

Designed for determining the composition. With penciled grid lines (6mm<sup>2</sup> squares) for alignment.

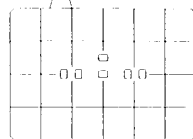

## ■ CAMERA FUNCTIONS AVAILABLE WITH VARIOUS LENSES

| FUNCTION   | Lens<br>[Mount type] | FA lens<br>[K <sub>AF</sub> /K <sub>AF2</sub> ] | F lens<br>[K <sub>AF2</sub> ] | A lens<br>[K <sub>A</sub> ] | M lens<br>[K] | S lens<br>[Screw] |
|--|----------------------|---|-------------------------------|-----------------------------|---------------|-------------------|
| Autofocus (Lens only)<br>(Lens with AF Adapter 1.7X) |                      | ○   | ○                             | ×                           | ×             | ×                 |
|  |                      | —   | —                             | ○*1                         | ○*1           | ×                 |
| Manual focus (with F1)*2<br>(with Matte field)       |                      | ○*3   | ○*3                           | ○*3                         | ○*3           | ×                 |
|  |                      | ○   | ○                             | ○                           | ○             | ○                 |
| Six focus points                                     |                      | ○   | ○                             | ×                           | ×             | ×                 |
| Power zoom   |                      | ○*4   | ×                             | ×                           | ×             | ×                 |
| Programmed AE  |                      | ○*5   | ○*5                           | ○                           | ×             | ×                 |
| Aperture-Priority AE                                 |                      | ○   | ○                             | ○                           | ○             | ○                 |
| Shutter-Priority AE                                  |                      | ○*5   | ○*5                           | ○                           | ×             | ×                 |
| Metered Manual                                       |                      | ○   | ○                             | ○                           | ○             | ○                 |
| TTL Auto Flash                                       |                      | ○   | ○                             | ○                           | ○             | ○                 |
| Multi(6)-segment metering                            |                      | ○   | ○                             | ○*6                         | ×             | ×                 |
| Approx. f-stop indication                            |                      | ○   | ○                             | ×                           | ×             | ×                 |



- \*1. Lenses with a maximum aperture of f/2.8 or larger. (See AF Adapter operating manual.)
- \*2. Manual focusing using the focus indicator (FI) (●) in the viewfinder.
- \*3. Lenses with a maximum aperture of f/5.6 or larger.
- \*4. Pentax-FA zoom lenses with the power zoom contacts only (K<sub>AF2</sub> mount).
- \*5. Exception of Pentax-FA Soft 85mm f/2.8 and FA-soft 28mm f/2.8.
- \*6. With A50mmf/1.2, the center-weighted metering or Spot metering is used instead of the multi-(6) segment metering mode.
- \*7. Multi(6)-segment metering, if selected, will be switched to center-weighted metering.

# TROUBLE SHOOTING

Before requesting service, please check the following points.

## ◆ Nothing is displayed on the LCD panel.

**Check 1: Power is OFF.**

**Countermeasure** Turn the power switch to ON ( 128 22).

**Check 2: Batteries are not inserted or inserted backwards.**

**Countermeasure** Check the insertion direction of the batteries and insert the batteries correctly ( 128 13).

**Check 3: The batteries are exhausted.**

**Countermeasure** Replace the batteries with new ones ( 128 13).

## ◆ Shutter does not trip.

**Check 1: Power is OFF.**

**Countermeasure** Turn the main switch to ON ( 128 22).

**Check 2: Batteries are not inserted or are inserted backwards.**

**Countermeasure** Check the insertion direction of the batteries and insert the batteries correctly ( 128 13).

**Check 3: The "Battery Warning" is blinking.**

**Countermeasure** Replace the batteries with new ones ( 128 13).

**Check 4: The exposure compensation dial is set to the [D] position, [PF] position or [ISO] position.**

**Countermeasure** Set the exposure compensation dial to a position other than the [D] position, [PF] position or [ISO] position. ( 128 65)

**Check 5: The built-in flash is charging.**

**Countermeasure** Wait until charging is finished ( 128 32).

## ◆ Subject is out of focus.

**Check 1: The subject to be focused on is not inside the AF frame.**

**Countermeasure** Cover the subject you wish to photograph within the AF frame before shooting ( 128 27).

**Check 2: The picture-taking distance is too close.**

**Countermeasure** Move away from the subject to be photographed ( 128 73).

**Check 3: The subject is not suited for autofocus ( 128 75).**

**Countermeasure** Use focus-lock to focus on a subject which is about the same distance as the subject to be photographed (page 81), or set the focus mode switch to the [MF] position and then use the mat screen to focus manually ( 128 76)

**Check 4: The focus mode switch is at the [MF] position.**

**Countermeasure** Use the focusing indicator and mat screen to adjust the focus manually (see page 77). Or set the focus mode switch to the [AF.S] position before taking pictures ( 128 74).

**Check 5: The focus mode switch is at the [A.F.C] position.**

**Countermeasure** In the [A.F.C] (continuous mode) position, the camera continues to focus on the subject to be photographed so that the shutter might be tripped even in a unfocused state ( 128 74).

**Check 6: The focus point is not set for the subject to be focused on.**

**Countermeasure** You can select the focus point position where you wish to focus ( 128 72).

**Check 7: The subject to be focused on is outside the range of focus point.**

**Countermeasure** First focus within the range of focus points on the subject you wish to photograph and then set the focus (focus lock) ( 128 80).

## ◆ Auto-Focus does not function even when the shutter button is pressed halfway down .

**Check 1: Pentax function No.16 has been set to [2].**

**Countermeasure** If the setting number [2] is set with Pentax function No. 16, focusing is not possible by pressing the shutter button halfway down. Press the AF button to adjust the focus. When focusing by pressing the shutter button halfway down, set to setting number [1] with Pentax Function No. 16.

### ◆ Exposure counter is not displayed or does not advance.

**Check 1:** [E] is blinking on the LCD panel.

**Countermeasure** Film has not been loaded properly. Load the film again ( 100 20).

**Check 2:** Camera is set to multiple exposure photography

**Countermeasure** If the drive switch is set to multiple exposure, pictures are taken repeatedly on the same frame. Set to another picture-taking mode ( 100 49).

### ◆ Film does not rewind automatically when finished.

**Check 1:** Pentax function No.13 has been set to number [2].

**Countermeasure** If setting number [2] is set with Pentax function No. 13 the film does not rewind automatically ( 100 119). Press the rewind button to rewind the film.  
For automatic rewind when the film is finished, set setting number [1] with Pentax function No. 13.

### ◆ The shutter speed and aperture value are blinking in the viewfinder.

**Check 1:** When set to the Programmed AE Mode.

**Countermeasure** The subject to be photographed is either too bright or too dark. If too bright, point the camera to a slightly darker area. If the subject is too dark, point the camera to a slightly brighter area ( 100 58).

**Check 2:** When set to Shutter-Priority AE Mode (shutter speed blinks)

**Countermeasure** The subject to be photographed is either too bright or too dark. If too bright, increase the shutter speed. If too dark, decrease the shutter speed ( 100 60).

**Check 3:** If set to the Aperture-Priority AE Mode (shutter speed blinks).

**Countermeasure** The subject to be photographed is either too bright or too dark. If too bright, set the aperture value to the small aperture side (with higher numbers). If too dark, set the aperture value to the open side (with lower numbers) ( 100 62).

### ◆ The exposure and shutter speed cannot be changed.

**Check 1:** The HOLD switch is on the right.

**Countermeasure** If the HOLD switch is on the right, the exposure mode and shutter speed cannot be changed, even by adjusting the select dial or pressing the exposure mode reset button. Put the HOLD switch on the left side ( 100 57).

### ◆ The built-in flash does not fire.

**Check 1:** The built-in flash is charging.

**Countermeasure** Wait until charging is finished ( 100 32).

**Check 2:** The "Battery Warning" symbol is blinking.

**Countermeasure** Replace the batteries with new ones ( 100 13).

**Check 3:** The flash mode is set to [A] (auto flashing mode).

**Countermeasure** If the subject to be photographed in the auto flash mode is bright, the flash will not light. Set to the flash ON mode to cause lighting even for bright subjects ( 100 84).

### ◆ Imprinting exposure data on negative is faint.

**Check 1:** Imprinting data information on a picture is faint.

**Countermeasure** Replace the data back's battery (CR2025) ( 100 42).

**Check 2:** Imprinting exposure data on the negative is faint.

**Countermeasure** Adjust the printing density level with Pentax function No.15 ( 100 120).

## SPECIFICATIONS TABLE

|                         |  |
|-------------------------|--|
| ● Type                  | TTL autofocus, auto-exposure multi-mode 35mm SLR with built-in TTL auto flash (RTF)  |
| ● Format                | 24 × 36mm  |
| ● Usable Film           | 35mm perforated cartridge film. DX-coded film with ISO 25-5000; non-DX coded films with ISO 6-6400   |
| ● Exposure Modes        | Programmed AE Mode, Shutter-Priority AE Mode, Aperture-Priority AE Mode, Metered Manual Mode, Bulb Mode, TTL Flash Mode  |
| ● Shutter               | Electronically controlled vertical-run focal-plane shutter, Electromagnetic release, Speed range: (1)Auto 1/6000-30 sec.(stepless),(2)Manual 1/6000-30 sec.(3)Bulb,  |
| ● Lens Mount            | Pentax KAF2 bayonet mount (K-mount with AF coupler, lens information contacts and power contacts), Lens mount index lamp equipped.   |
| ● Compatible Lens       | Pentax KAF2-, KAF-,KA-, and K-mount lenses are usable. Autofocus is possible using AF Adapter with KA-and K-mount lenses.  |
| ● Autofocus System      | TTL phase-matching multi-(6 points) autofocus system switchable to Spot focusing, AF operational brightness range: EV -1 to 18(at ISO 100 with f/1.4 lens), Focus lock available using shutter release button/AF button, Focus Mode: AFS(single), AFC(predictive AF), Manual[MF]. Possible to select the focus point.                  |
| ● Power Zoom            | 3-Speed Power Zoom lens with built-in motor with FA zoom lens with KAF2 mount.   |
| ● Viewfinder            | Fixed pentaprism, Interchangeable Natural-Bright-Matte focusing screen, Field of view:92%, Magnification:0.75X(with 50mm f/1.4 lens at infinity ), Diopter: -2.5 to +1.5m <sup>-1</sup>  |
| ● Viewfinder Indication | Focus Information: In-focus (Green lamp [●] is lit), front or back focus signals and unable-to-focus indicator (Green lamp blinks), Shutter speed indication, Aperture indication, Flash ready indication [⚡] is lit, Bar graph=exposure compensation, Over or Under exposure indication in Manual Exposure Mode, [✱] AE lockindicator |

|                                 |  |
|---------------------------------|--|
| ● External LCD panel Indication | [P]=Programmed-AE Mode, [Tv]=Shutter-Priority AE Mode, [Av]=Aperture-Priority AE Mode, [M]=Manual Exposure Mode, [bu]=Bulb Mode, Film speed=6 - 6400, ISO indication, Shutter Speed, Aperture val [D]=Setting Exposure imprint mode, [●---○]=Film status information, [⚡]=Battery exhaustion warning, [⚡]=Built-in flash ready indication, [⚡]=blinking slowly flash recommended warning, [⚡]=blinks rapidly Inappropriate lens warning, [⊙]=Red-eye reduction flash mode, [A]=Automatic flash function, [W]=Wireless flash mode, [HS]=High-speed flash sync mode, Film counter=0-99, [P]=Pentax function, [●]=PCV signal indication, Illumination for LCD panel |
| ● Preview Button                | Electronically controlled type and possible to use in all exposure modes   |
| ● Self-timer                    | Electronically-controlled type with delay time of 12 sec. or 2 sec delay when mirror-lock up in use. Start by depressing of shutter release button, Operation confirmation: Possible to set PCV beep tone by Pentax function. Cancelable after operation.  |
| ● Auto bracketing               | Three frame consecutive shots with exposure bracketing in 1 EV or 0.5 EV step. increment, Possible to change the sequence and number of auto bracketing exposure by Pentax function. Possible to use with exposure compensation  |
| ● Mirror                        | Quick-return mirror with AF secondary mirror. Mirror lock-up is possible with 2 sec. delay self-timer.   |
| ● Film Loading                  | Film advances automatically to 1st frame after back cover is closed, Film information window is provided.  |
| ● Film Wind & Rewind            | Auto wind/rewind by built-in motor, Consecutive or Single advance mode, Approx.2.5 frames/sec (consecutive mode), Auto rewinding starts at end of roll, Film rewind/completion of rewinding is displayed on the LCD panel, mid-roll rewind button will rewind film in mid-roll.  |
| ● Exposure Meter                | TTL multi(6)-segment metering, Metering range from EV0 to EV21 at ISO100 with 50mm f/1.4 lens, Center-weighted and Spot metering mode can be set.  |
| ● Exposure Compensation         | ±3EV in 0.5EV step increments  |
| ● AE lock:                      | Set by AE lock button, current exposure value remains for 20 sec. With the shutter release button pressed halfway down pressed, the exposure value remains continuously.   |

|                              |  |
|------------------------------|--|
| ● Imprinting exposure data   | Possible to imprint the exposure data on the outside of the picture frame. Possible to imprint the total number of rolls taken, ISO film speed, exposure density, exposure mode, metering system, shutter speed, aperture, exposure compensation value, auto bracketing exposure.  |
| ● Flash                      | Series-control, Retractable TTL Auto Flash (RTF), Guide number: 12 (ISO100/m), Illumination angle covers 24mm lens angle of view, Flash-sync-speed in the range from 1/180 to a slower speed, Slow-speed-sync flash, Contrast-control-flash sync (ISO range=25-800), Automatic flash discharge, Red-eye reduction flash function |
| ● Flash sync                 | Hot shoe with X-contact with couples with Pentax dedicated auto flashes, ISO range=25-800, Flash-sync-speed in the range from 1/180 to a slower speed. Possible to use high-speed sync, wireless flash mode with AF360FGZ.   |
| ● Pentax function            | 19 user-defined functions  |
| ● Power source               | Two 3V lithium batteries (CR-2 or the equivalent)  |
| ● Battery Exhaustion Warning | Battery exhaustion symbol [  ] is lit (blinking when the shutter is locked; no indication on the right-hand edge of the viewfinder.)  |
| ● Dimension and Weight       | 136.5mm(W) x 95mm(H) x 64mm(D) (5.4" x 3.7" x 2.5") 520g (18.3 oz) body only without batteries   |
| ● Supplied Accessories       | Hot Shoe Cover FL, Release Socket Cap, Camera Strap FG, Eye Cup FL, Finder Cap   |
| <b>About Back Cover</b>      | Crystal quartz controlled; LCD with digital clock, auto calendar up to 2049.   |
| ● Data printout              | 7-segment, 6-digit LCD   |
| ● Printout confirmation      | "-" indication blinks for a few seconds on LCD panel.  |
| ● Printing mode              | ① Year/month/day, ② day/hour/minute, ③ "---", ④ month/day/year, day/month/year   |
| ● ISO range                  | ISO 25-1600 (automatic setting)  |
| ● Power source               | CR2025 (lithium battery)   |
| ● Number of prints           | Approx. 5,000  |

SPECIFICATIONS ARE SUBJECT TO CHANGE AT ANY TIME WITHOUT NOTIFICATION OR ANY OBLIGATION ON THE PART OF THE MANUFACTURER.

## For customers in the USA

### STATEMENT OF FCC COMPLIANCE

This device complies with Part 15 of the FCC Rules. Operation is subject to the following two conditions: (1) This device may not cause harmful interference, and (2) this device must accept any interference received, including interference that may cause undesired operation.

Changes or modifications not approved by the party responsible for compliance could void the user's authority to operate the equipment.

This equipment has been tested and found comply with the limits for a Class B digital device, pursuant to part 15 of the FCC Rules. These limits are designed to provide reasonable protection against harmful interference in a residential installation. This equipment generates, uses and can radiate frequency energy and, if not installed and used in accordance with the instructions, may cause harmful interference to radio communications. However, there is no guarantee that interference will not occur in a particular installation. If this equipment does not cause harmful interference to radio or television reception, which can be determined by turning the equipment off and on, the user is encouraged to try to correct the interference by one or more of the following measures:

- Reorient or relocate the receiving antenna.
- Increase the separation between the equipment and receiver.
- Consult the dealer or an experienced radio/TV technician for help.

## For customers in Canada

This Class B digital apparatus meets all requirements of the Canadian Interference - Causing Equipment Regulations.

## Pour les utilisateurs au Canada

Cet appareil numérique de la classe B respecte toutes les exigences du Règlement sur le matériel brouilleur du Canada.

## WARRANTY POLICY

All Pentax cameras purchased through authorized bona fide photographic distribution channels are guaranteed against defects of material or workmanship for a period of twelve months from date of purchase. Service will be rendered, and defective parts will be replaced without cost to you within that period, provided the equipment does not show evidence of impact, sand or liquid damage, mishandling, tampering, battery or chemical corrosion, operation contrary to operating instructions, or modification by an unauthorized repair shop. The manufacturer or its authorized representatives shall not be liable for any repair or alterations except those made with its written consent and shall not be liable for damages from delay or loss of use or from other indirect or consequential damages of any kind, whether caused by defective material or workmanship or otherwise; and it is expressly agreed that the liability of the manufacturer or its representatives under all guarantees or warranties, whether expressed or implied, is strictly limited to the replacement of parts as hereinbefore provided. No refunds will be made on repairs by non-authorized Pentax service facilities.

### Procedure During 12-month Warranty Period

Any Pentax which proves defective during the 12-month warranty period should be returned to the dealer from whom you purchased the equipment or to the manufacturer. If there is no representatives of the manufacturer in your country, send the equipment to the manufacturer, with postage prepaid. In this case, it will take a considerable length of time before the equipment can be returned to you owing to the complicated customs procedures required. If the equipment is covered by warranty, repairs will be made and parts replaced free of charge, and the equipment will be returned to you upon completion of servicing. If the equipment is not covered by warranty, regular charges of the manufacturer or of its representatives will apply. Shipping charges are to be borne by the owner. If your Pentax was purchased outside of the country where you wish to have it serviced during the warranty period, regular handling and servicing fees may be charged by the manufacturer's representatives in that country. Notwithstanding this, your Pentax returned to the manufacturer will be serviced free of charge according to this procedure and warranty policy.

In any case, however, shipping charges and customs clearance fees to be borne by the sender. To prove the date of your purchase when required, please keep the receipt or bills covering the purchase of your equipment for at least a year. Before sending your equipment for servicing, please make sure that you are sending it to the manufacturer's authorized representatives or their approved repair shops, unless you are sending it directly to the manufacturer. Always obtain a quotation for the service charge, and only after you accept the quoted service charge, instruct the service station to proceed with the servicing.

**The local warranty policies available from Pentax distributors in some countries can supersede this warranty policy. Therefore, we recommend that you review the warranty card supplied with your product at the time of purchase, or contact the PENTAX distributor in your country for more information and to receive a copy of the warranty policy.**



- Asahi Optical Co., Ltd.** 36-9 Maeno cho 2-chome, Itabashi-ku, Tokyo 174-8639, JAPAN  
(<http://www.pentax.co.jp/>)
- Pentax GmbH** (European Headquarters) Julius-Vosseler-Strasse 104, 22527 Hamburg, GERMANY  
(<http://HQ//pentaxeuropa.com/> <http://www.pentax.de/>)
- Pentax U.K. Limited** Pentax House, Heron Drive, Langley, Slough Berks SL3 8PN, U.K.  
(<http://www.pentax.co.uk/>)
- Pentax FRANCE S.A.** 12/14, rue Jean Poulmarch, 95100 Argenteuil, FRANCE
- Pentax Benelux B.V.** (for Netherlands) Spinveld 25, 4815 HR Breda, NETHERLANDS  
(<http://www.pentax.nl/>)  
(for Belgium & Luxembourg) Weiveldlaan 3-5, 1930 Zaventem, BELGIUM  
(<http://www.pentax.be/>)
- Pentax (Schweiz) AG** Industriestraße 2, 8305 Dietlikon, SWITZERLAND (<http://www.pentax.ch/>)
- Pentax Scandinavia AB** P.O. Box 650, 75127 Uppsala, SWEDEN (<http://www.pentax.se/>)
- Pentax Europe n.v.** (European Distribution Centre) Weiveldlaan 3-5, 1930 Zaventem, BELGIUM
- Pentax Corporation** 35 Inverness Drive East, Englewood, Colorado 80112, U.S.A.  
(<http://www.pentax.com/>)
- Pentax Canada Inc.** 3131 Universal Drive, Mississauga, Ontario L4X 2E5, CANADA



The CE marking assures that this product complies with the requirements of the EC directive for safety.

This operating manual is printed on recycled paper.